

PowerShift® Installation Instructions

Controller Software Version: 4.8.138

The patented PowerShift system is designed to optimize electrical draw by adjusting voltage dynamically to match your exact RRU power requirements up to 650 feet using 4 or 6 AWG Power Cable trunks.

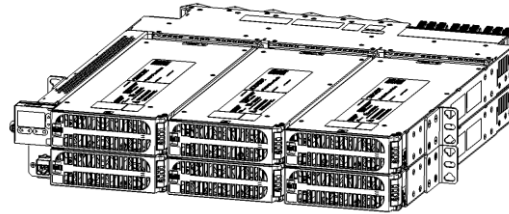

Section 1: PowerShift System Components / General Specifications	02
Section 2: Installation Check List	04
Section 3: General Wiring Diagram.....	05
Section 4: Configuration - Tower, Rooftop / Boost module Population Options.....	06
Section 5: RS485 Serial Connections / Input Power from DC Power Plant	07
Section 6: Redundant Boost module Population Options	08
Section 7: Power Cable Mapping	09
Section 8: Circuit Map Worksheet (Leave on-site)	10
Section 9: Rack Installation / Controller Installation.....	10
Section 10: Wiring of the Rack / Lug Preparation / Wiring Sequence.....	12
Section 11: Power Up and Configuration Procedure.....	16
Section 12: Closeout Package	30
Section 13: Troubleshooting Raycap Issues	31
Section 14: PowerShift Alarms and Troubleshooting.....	33
Section 15: Alarm / GP / RS485 Connectors	37

Field Engineering Services (FES)

Support services, such as our Field Engineering Services (FES) Group gives CommScope customers access to technical support where and when it is needed the most — in the field. The FES team is staffed by an expert team of technicians who, in turn, are supported by some of the brightest and most experienced product line managers.

Customer Service Center

United States and Mexico 1-888-297-6433 (technical support) or 1-888-235-5732 (main number)
International: +1-779-435-8579

For the most current, up-to-date information on all our products and product information please visit our eCatalog section at www.commscope.com.

Section 1: PowerShift System Components

The PowerShift System consists of the following components: single (PS-R-V4-M) or dual shelf (PS-R-V4-MS), one controller card (PS-CNTRL-V4), one or more modules (PS-2000-73), and Raycap OVP equipment (optional).

The PowerShift system is used in conjunction with the existing DC power plant at the installation site.

1. The shelf has capacity for 1 to 6 modules depending on configuration; bypass is integrated into module.
2. The modules are plug-and-play for easy installation and site maintenance.
3. Each module has DC input and DC output for three Remote Radio Units (RRU), for a total capacity of 9 RRU sectors per PowerShift shelf; 18 RRU sectors for a dual PowerShift shelf.
4. Each module unit is also provided with LED diagnostic indicators, explained in section 14.
5. The shelf can adjust voltage levels based on feedback (FAT) from the Raycap equipment or be used independent of a Raycap. Once the initial voltage adjustments are made the systems maintains these settings until user intervention.

Rack Part Number:

PS-R-V4-M
 PS-R-V4-S
 PS-R-V4-MS

Boost Module Part Number:

PS-2000-73

Pulsar Edge Controller:

PS-CNTRL-V4

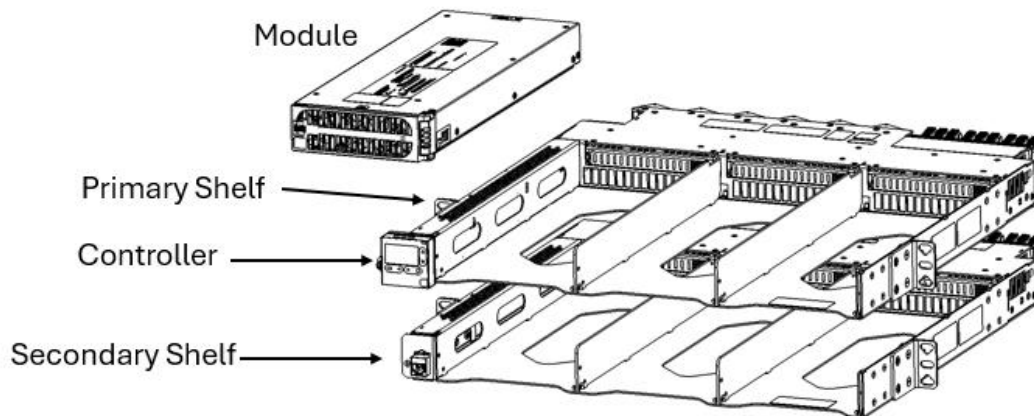

General Specifications (Module)

Electrical ¹	Typical	Range
Input Voltage ²	-54VDC	Cut-off: -40VDC Turn-on: -44VDC ³ Maximum: -58VDC
Input Current ²	15A	0-66 A @ -40 VDC
Efficiency	> 97%	> 95%
PS Output Voltage ²	-54 VDC	-48 to -73 VDC
PS Output Current ²	37.1 A	32 A (Selectable) 37.1 A (Default)
Output Voltage Ripple	400 mV rms	
Total Power output ⁴	2708 W (max boost) 2152 W (max bypass)	
Programmable RRU Voltage ⁵	-54V to -58V, 0.5 Volt Increments	
Gauge Range	0-6 AWG	
Length Range	150-650 ft (using 6AWG power cable) ⁶	

¹ Per circuit; 3 circuits per module

² Input/output voltage and current range are guaranteed values, actual operating values will typically exceed these up to 10%

³ Turn-on voltage is higher than cut-off voltage in order to provide hysteresis protection

⁴ Total power = power consumed by radio + power loss in trunk cable

⁵ RRU input voltage set-point is factory programmed. Other voltage set-point are possible, contact CommScope

⁶ 650ft of 6AWG ≈ 0.54 Ohms loop resistance. Longer cable lengths are possible, contact CommScope for more information

Section 2: Installation Check List

Note:) Raycap Installation may be option depending on PowerShift Configuration does not require OVP when in Resistance Mode: Manual.

- Install OVP base and top hardware using appropriate Raycap OVP documentation (e.g. Install Instructions RCMDC-6627-PF-48)
- Set OVP configuration switch as appropriate for base and top hardware (multiple base units must have unique address ID).
- Important: Ensure OVP rackmount configuration switch is set prior to rack installation (the switch may be inaccessible after rack installation)
- Install PowerShift Shelf
- Install cable (power, fiber and twisted pair) from base up to the tower/roof top (e.g., using CommScope hybrid trunk cable)
- Install cables between OVP tower/roof top hardware and remote radio units (power, fiber)
- Install power cables between DC plant circuit breakers and PowerShift Shelf input terminals
- Install power cables between PowerShift Shelf output terminals and OVP base input terminals
- Install RS485 data cable between PowerShift Shelf and OVP base hardware
- If multiple OVP base units are installed, install RS485 data cables between them (daisy chain)
- Connect trunk cables to OVP base hardware and connect to OVP tower/roof top hardware (power, twisted-pair, fiber)
- Complete all the steps in Section 11: Power Up and Configuration Procedure
- Confirm the site information and all radio circuit information has been entered in the GUI
- Confirm all the required files have been captured to your PC for inclusion in the installation closeout package
- Confirm there are no active alarms on the GUI or on the Raycap hardware
- Confirm the Circuit Map Worksheet is filled out and is left at the site
- If possible, bring the radios to full operational state (user traffic) and confirm proper operation

Section 3: General Wiring Diagram

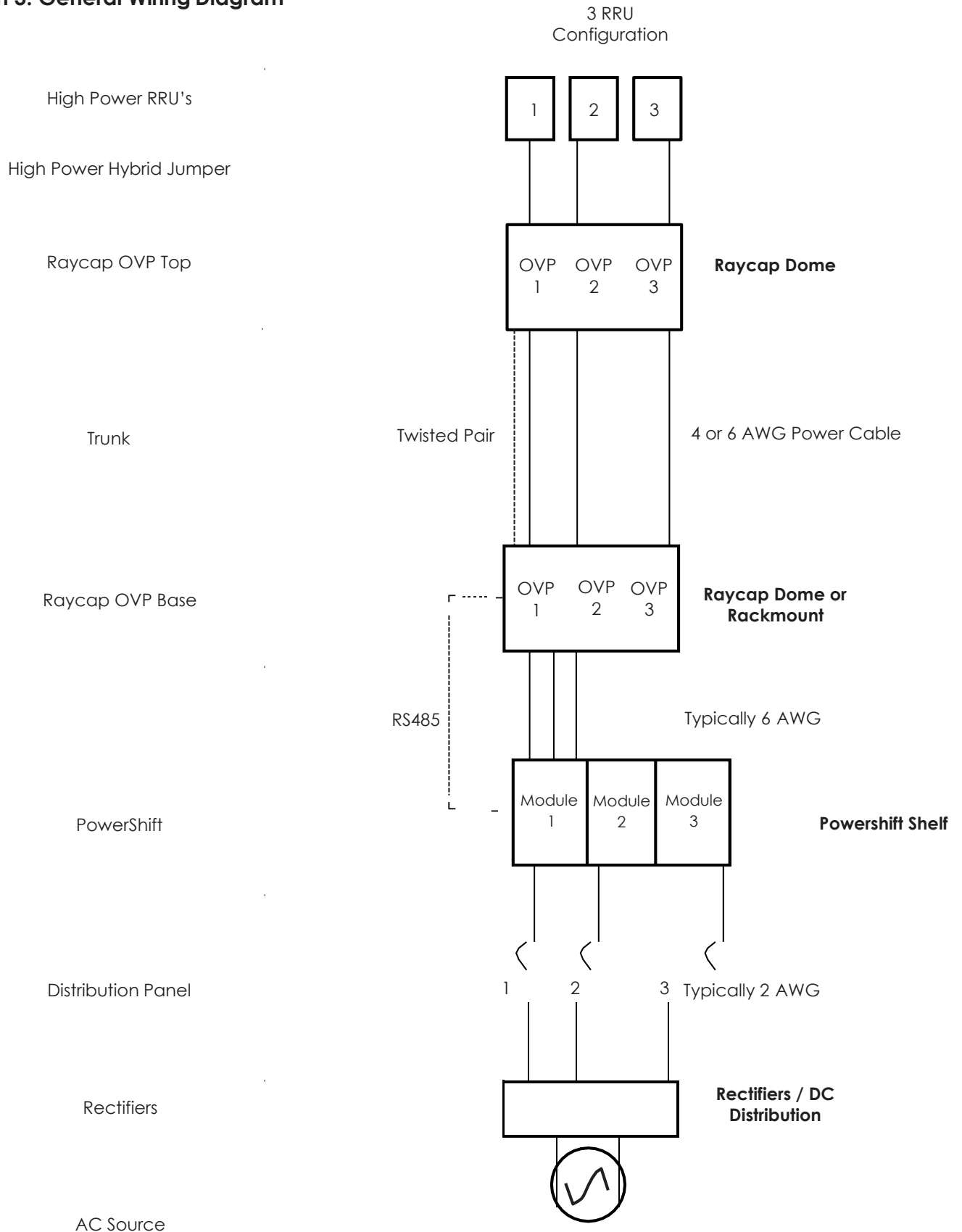

Section 4: Configurations

*Use standard Ethernet patch cable for RS485 connection

12 RRU Tower Top

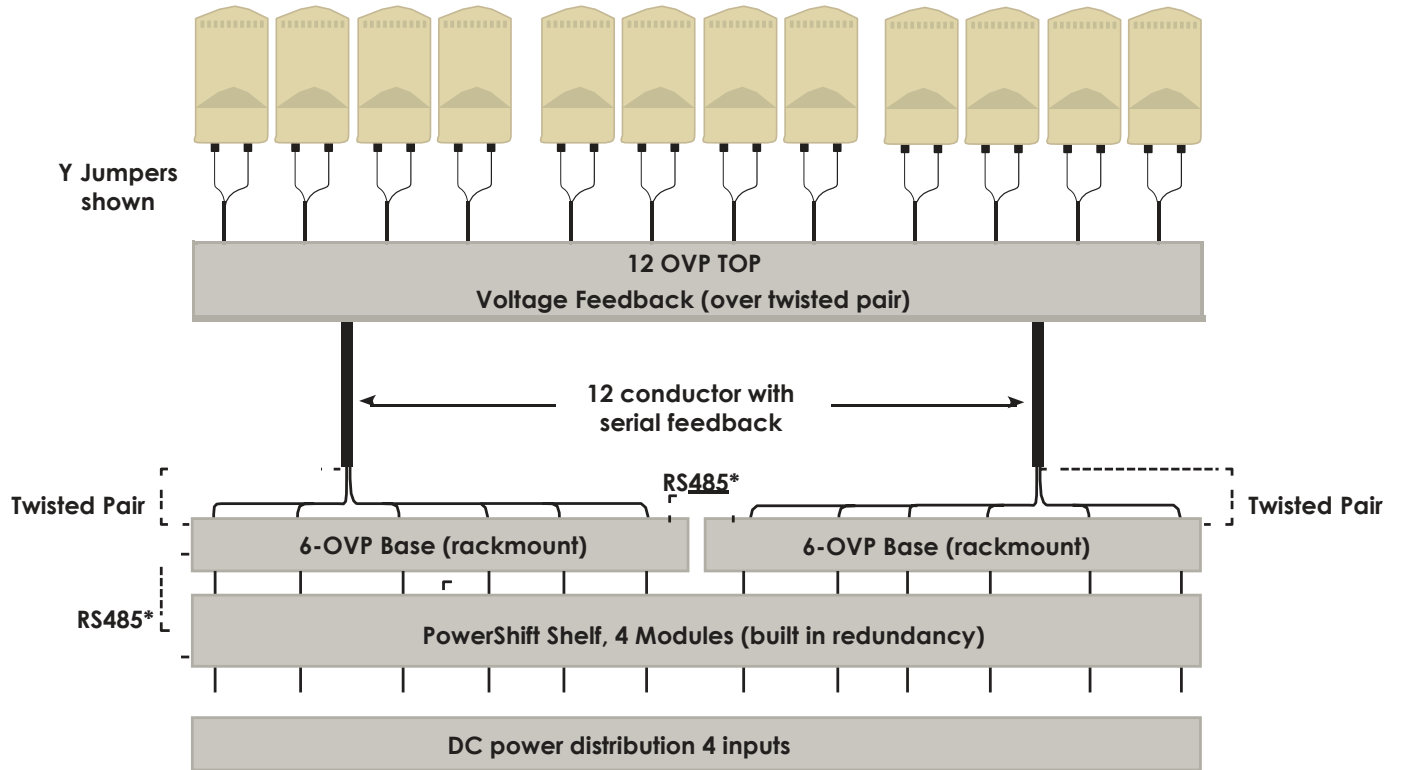

6 RRU Tower Top

*Use standard Ethernet patch cable for RS485 connection

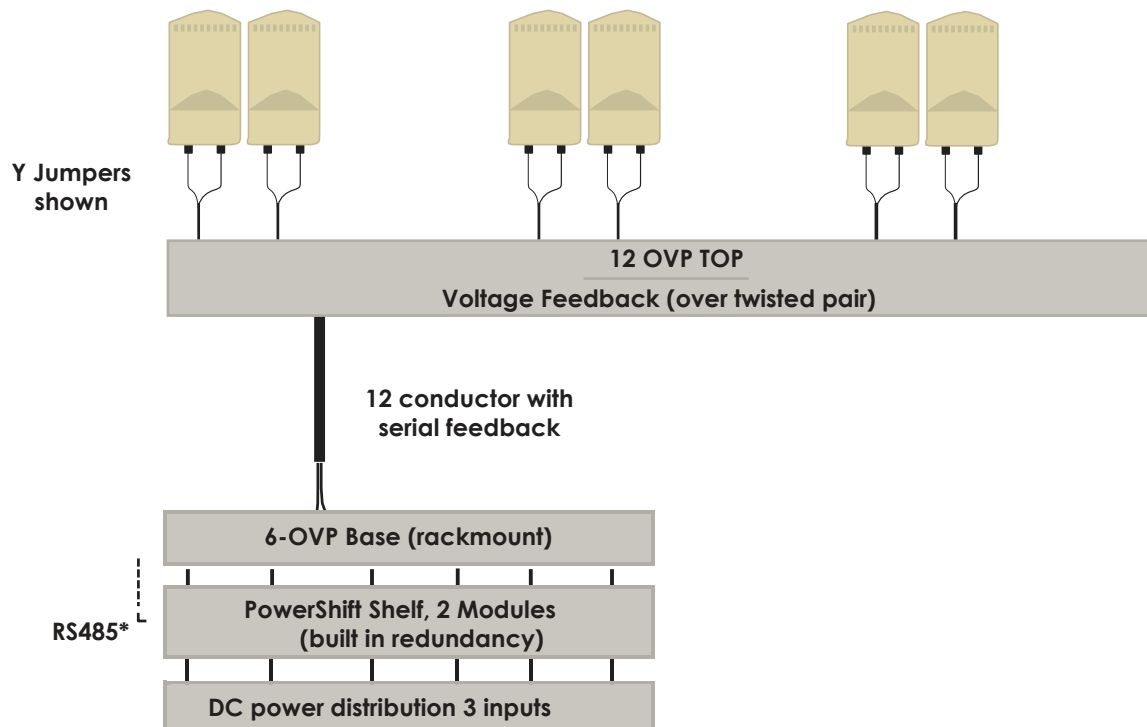

6 or 12 RRU Roof Top

*Use standard Ethernet patch cable for RS485 connection

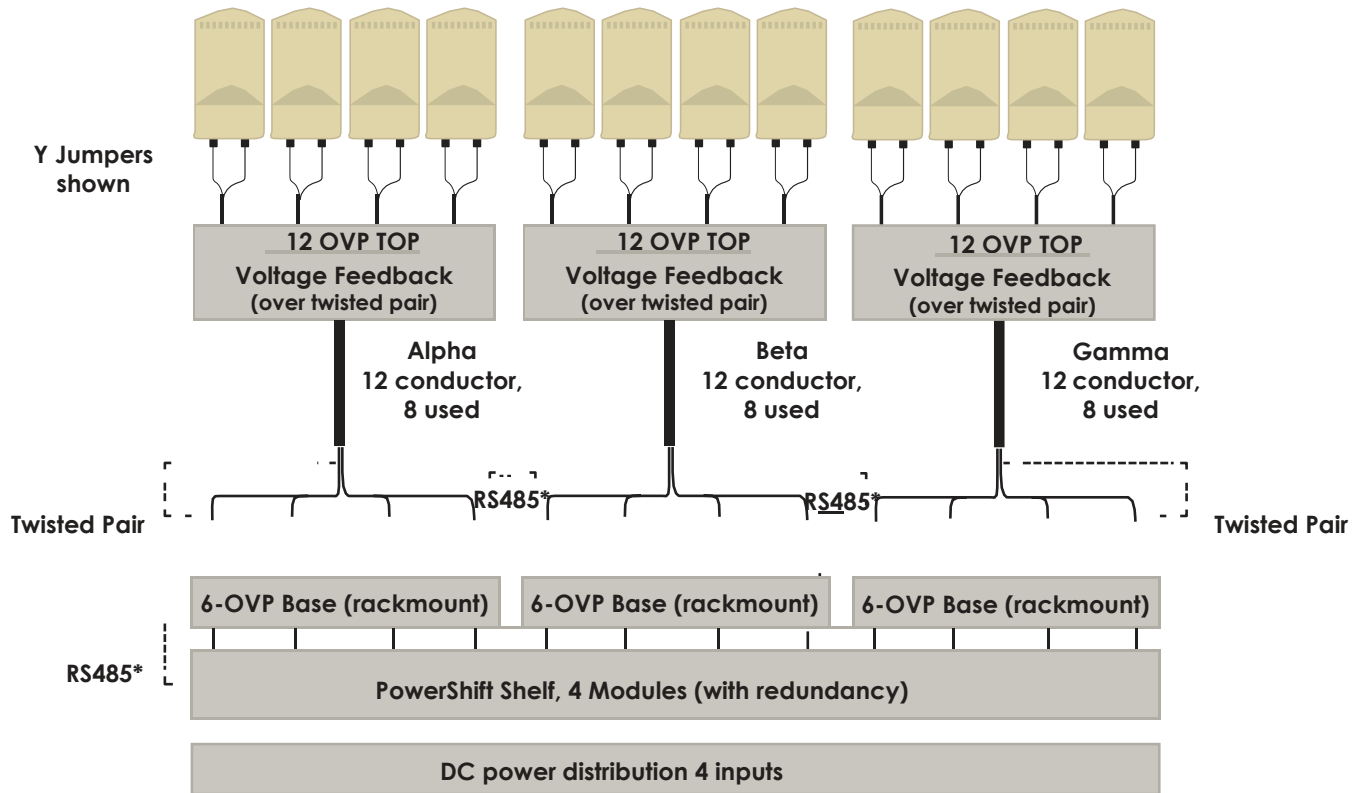

Section 5: RS485 Serial Connections / Input Power from DC Power Plant (Refer to Raycap for ID settings)

Tower Top

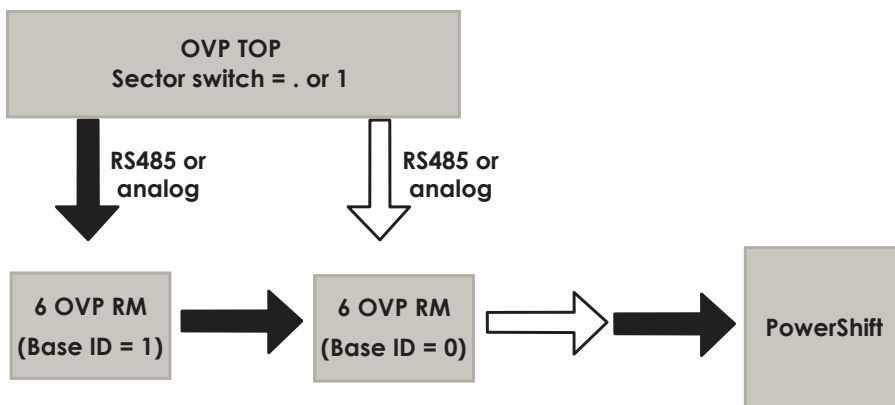

Roof Top

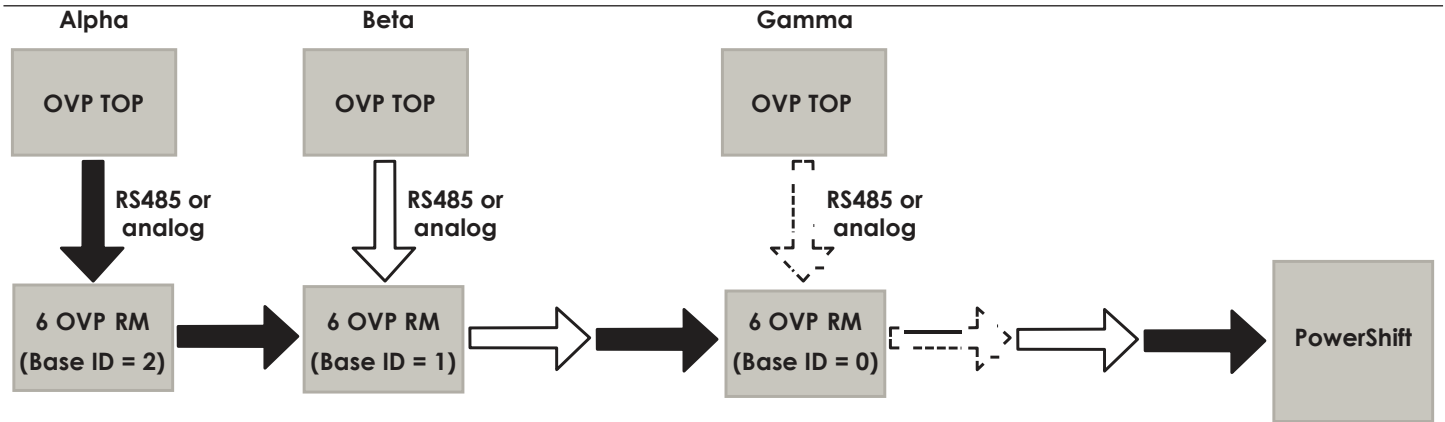

Section 6: Module Population Options

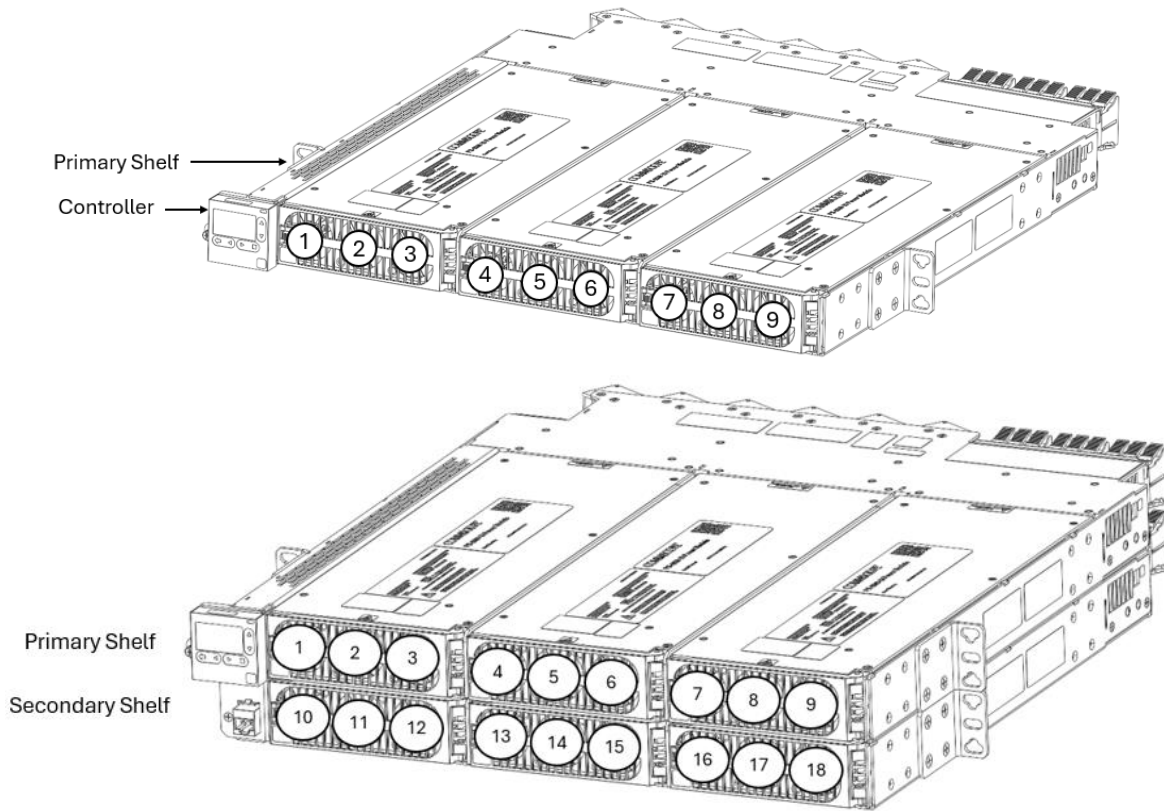

Note – PS-R-V4-M (9 Circuits)/PS-R-V4-MS(Option – 18 Circuits)

Built in module redundancy provides redundant functionality in the event of a boost circuit failure. Each circuit has the ability to go into bypass.

Section 7: Power Cable Mapping

6 RRU Top Dome / 6 RRU Base Rackmount (x2)

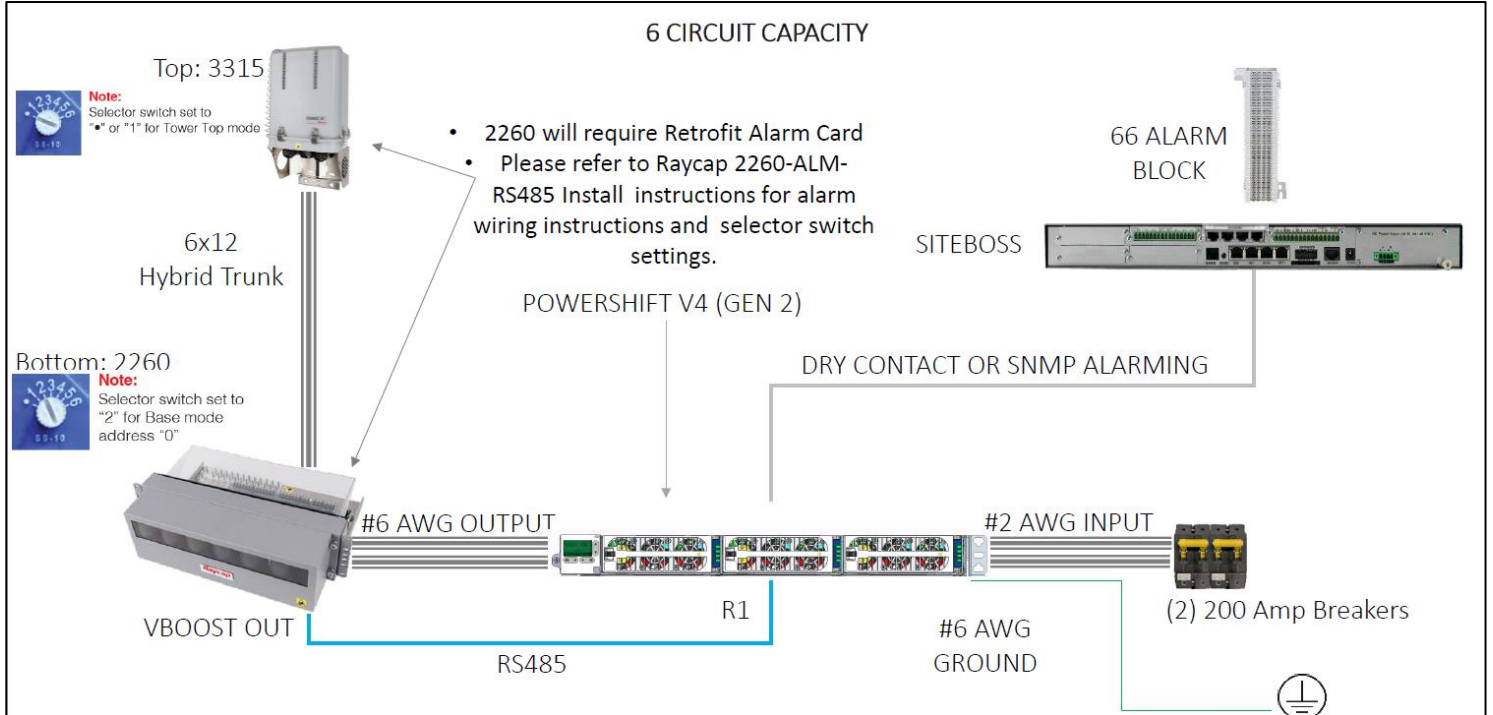

12 RRU Top Dome / 12 RRU Base Dome

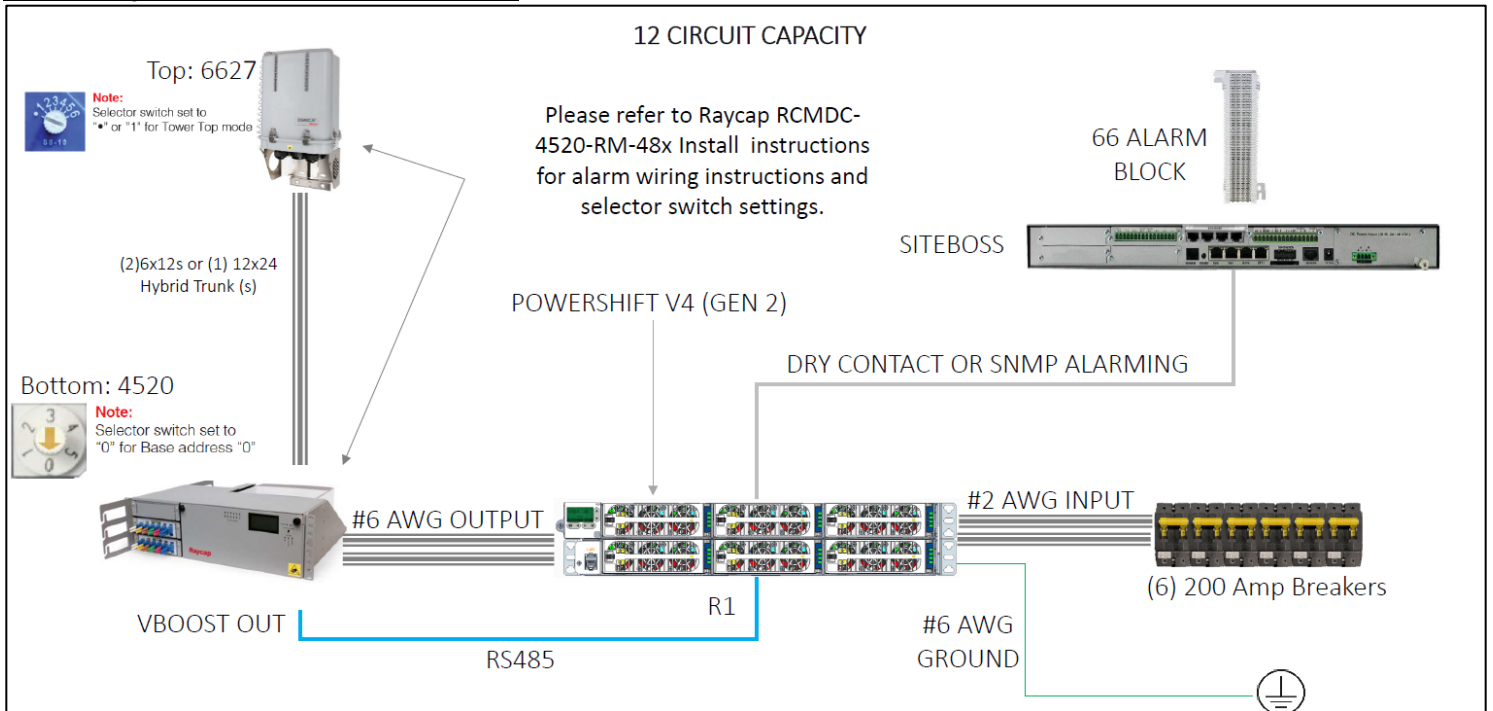

Section 8: Circuit Map Worksheet (leave on-site)

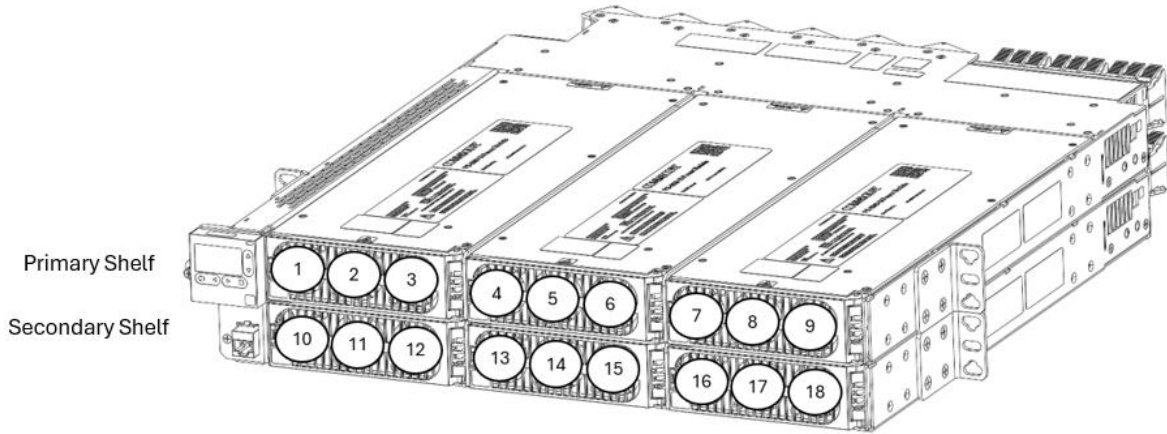

	PowerShift Circuit #	RRU #	RRU Sector	RRU Technology	Circuit Breaker #	OVP Base ID #	OVP Base Port #
Primary Shelf	1						
	2						
	3						
	4						
	5						
	6						
	7						
	8						
	9						
Secondary Shelf	10						
	11						
	12						
	13						
	14						
	15						
	16						
	17						
	18						

Date: _____

Contractor: _____

Section 9: Rack Installation/Controller Installation

Rack Installation

- 1) Determine the installation depth required for the base unit, attach the side flanges in the appropriate location. 9 screws are required per side.
- 2) Mount the unit in a standard 19" rack near the current DC power output breaker box.
- 3) Ground the unit by installing a 6AWG ground wire at the side of the unit.
- 4) Based on the Raycap model numbers, use the applicable Raycap installation instructions to install the Raycap top and bottom OVP hardware, and the associated power and data cabling.

Controller Installation

Install the Controller into the shelf as follows

- 1) Unbox the Controller but do not remove it from the anti-static bag
- 2) Using an ESD protective wrist strap, ground yourself to the PowerShift chassis
- 3) Remove the Controller from the anti-static bag, then slide the controller all the way in until the backplane connect fully seats.

Section 10: Wiring of the Rack

Note: For ease of access, install alarm cables (if required) and RS485 data cable before installing power cables:

- 1) If required, install dry-contact alarm relay wiring from back of shelf to site alarm block.

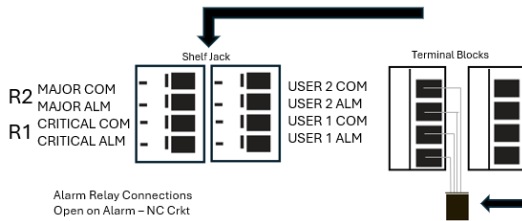

There are two detachable terminal blocks that hold the alarm wire harness and plug into the shelf jack; this illustration shows their orientation.

To cell site alarm block

- 2) Install RS485 data cable between the Raycap base unit (VBOOST OUTPUT port) and the PowerShift shelf (R1 port); use a standard Ethernet patch cable (the cable included with Raycap RCMDC-6627-PF-48 can be used)

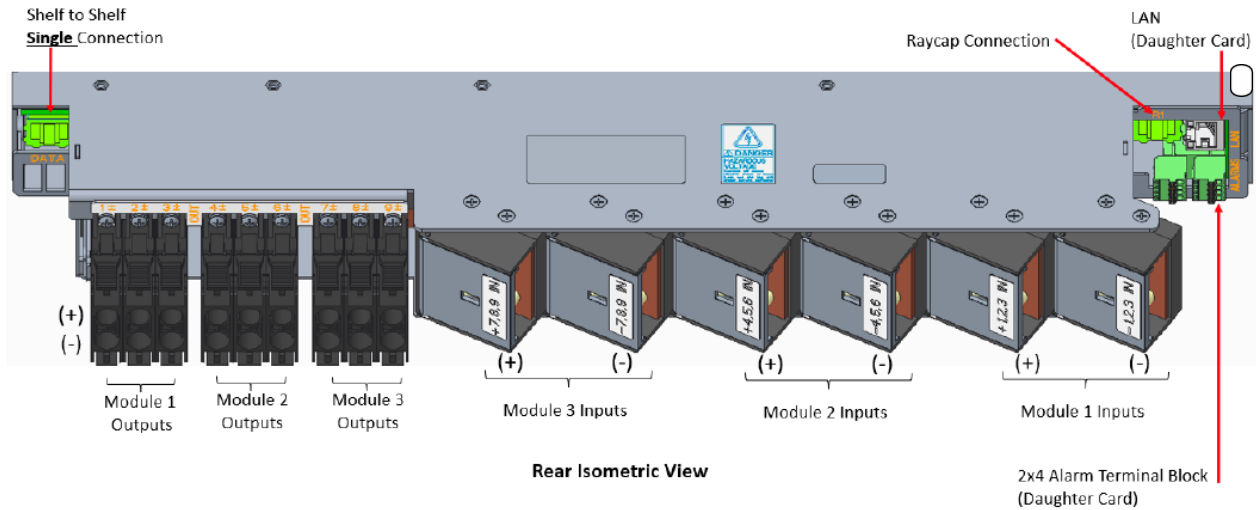

+ = Return (ground)
- = Supply (hot)

Communications to RayCap
OVP base (VBOOST OUTPUT)

RS485 data cable; use standard Ethernet cable or use the cable included with Raycap RCMDC=627-PF-48

- 3) As shown above, the rear of the shelf is divided into 9 or 18 individual circuits, each containing a two wire DC input and a two wire DC output. There is a positive and negative terminal strip connection for each DC input and out. Terminate the input power cables with a dual-hole lug as shown below. The output terminals should be terminated with the included Amphenol terminal plug.

Lug Preparation

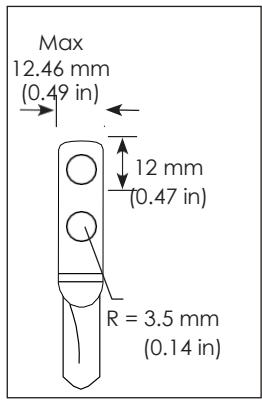
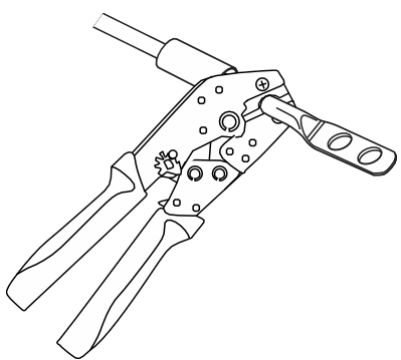
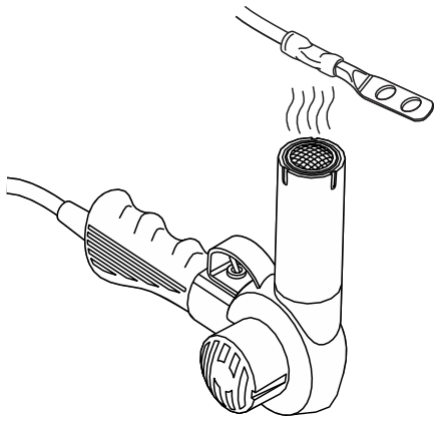
<p>1 Prep cable end and slide heat shrink tubing onto cable</p> 	<p>2 Crimp lug to wire</p> 	<p>3 Apply heat to shrink tube</p> 
--	---	---

Amphenol Preparation

PRM0400-G4-PLG 2 POSITION FEMALE QUICK CONNECT PLUG KIT. PRM SERIES™, POWER RACK MOUNT. 4.0MM MACHINED RADSOK® R8S SOCKET CONTACTS, RETAINER CLIP, WIRE RANGE 6-8AWG, 70A



SC000532-6-R4 4.0MM FEMALE SOCKET, 6-8AWG MACHINED RADSOK® R8S CONTACT



RETAINER CLIP



Burndy Y1MRTC Hand Crimping Tool



50-80639 4.0MM, EXTRACTION TOOL



Remove ferrule from packaging, look for end that has "sight window".



Strip 6AWG Telco Flex \approx 12.3mm/0.5in



Insert cable into ferrule, crimp ferrule 2 times using the 6AWG die on standard hand crimp tool



Confirm cable polarity matches connector prior to installation into Connector Body.

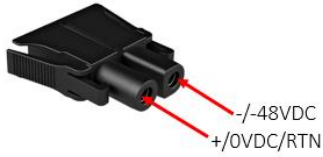

After both ferrules have been crimped, insert cables in Connector body and insert retaining clip

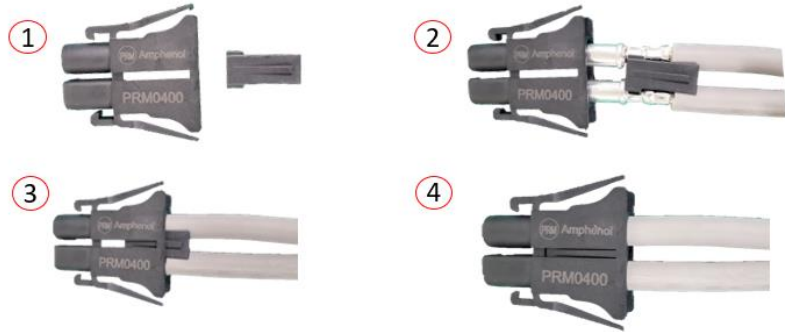

Wiring Sequence

Note: Connect PowerShift input and output power cables using the wiring sequence shown below (outside to inside, bottom to top); this is recommended based on the typical route of input and output cable into a rack (i.e., cables usually run from top of rack downward to PowerShift shelf).

- 1) Attach site DC power supply lines from the distribution panel to the input terminals on PowerShift rack
- 2) Attach power output cables from the PowerShift rack to the OVP base panel/box.
- 3) Repeat for each circuit. Recommend completely wiring all input and output cable pairs into the shelf during installation, even if 9 or 18 modules are not being installed; this will ease future installation of additional radios.

**Wiring Sequence A-F
(outside to inside, bottom to top)**

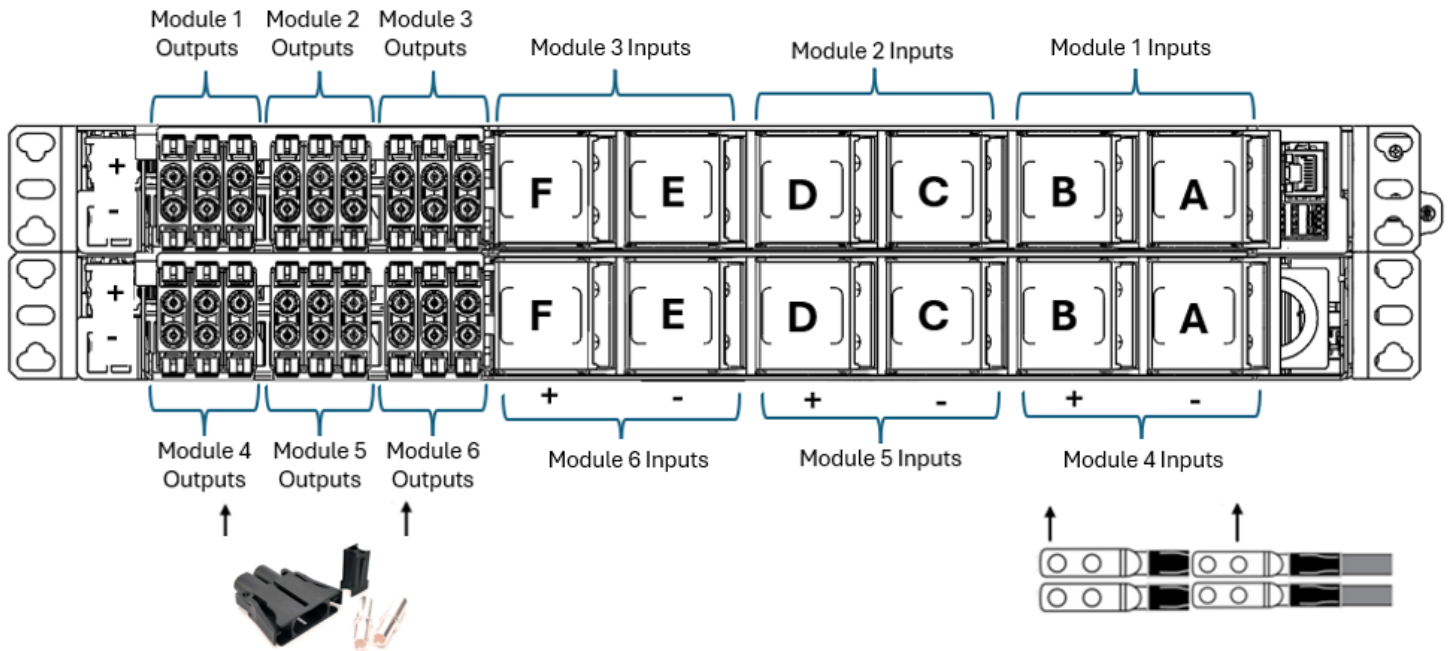

Section 11: Power Up and Configuration Procedure

Note: Module Hot Swap

If a module is removed during operation the power to the radio will be lost.

The controller card can be hot swapped while the system is operational, power to the radios will not be interrupted. However note the following:

- The modules will re-adjust their boosted voltage output based on the load current demanded by the radio and the newly calculated ALR.
- If there are other large changes to circuit conditions, such as a significant change in cable resistance, operational adjustments will be made when the controller is installed.

Apply Input Power

1) Turn on DC plant circuit breaker for PowerShift Module 1, confirm activation of the Controller, LCD Display

Note: The Controller, Display obtain power from the Shelf input terminals, at least one circuit must have input power applied.

- 2) The Controller LEDs should cycle off and on, the LCD display backlight should illuminate
- 3) After 10-30 seconds:
 - a) The Controller card SYS LED should illuminate solid green or red
 - b) The Display should show the text "U" in the center/left of the screen (the backlight may be either green, yellow or red)



- 4) Use a Windows PC and web browser (Chrome is preferred) to connect to the LAN port on the back(PS-R-V4-M) or front(PS-R-V4-MS) of the PowerShift Shelf
 - a) Connect a standard Ethernet patch cable between the PC and the Shelf LAN port; the PC Ethernet port LED should illuminate
 - b) The PC must be configured for DHCP operation on its Ethernet port
- 5) Open web browser on the PC and enter URL: 192.168.2.1, the GUI login page appears:

Note: When the Controller is powered up it may take 1-2 minutes before the web browser can connect, and then it may take 30 seconds or longer for the login page to appear

Troubleshooting: If the login page does not appear, open a command prompt (cmd) in Windows and use the following ping command to confirm a good connection to the controller: ping http://192.168.2.1

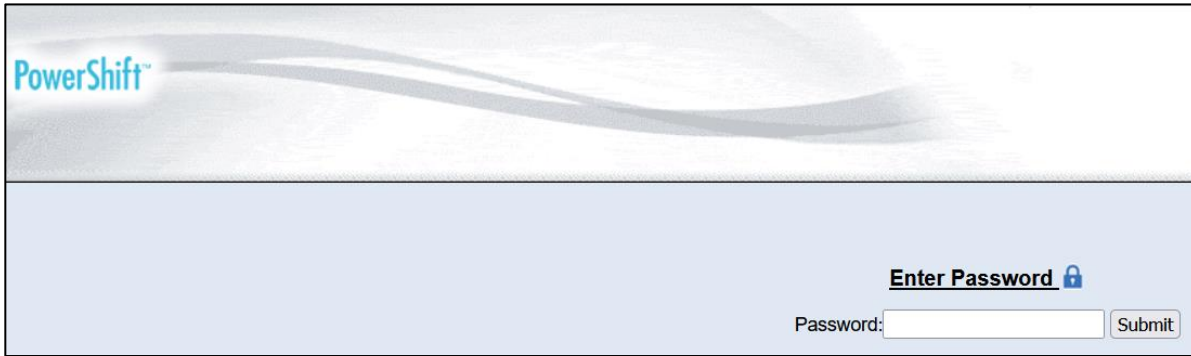

- 6) Enter the password: super-user (lower case, no spaces)
 - a) The default login does not require a user name, only a password
 - b) Click Submit, the GUI Home page appears:
 - c) Confirm the controller software version is 4.8.138 or higher
 - d) Click on the Installation tab, adjust the time and date, enter the site ID and description (e.g., site name or street address); click the Submit button

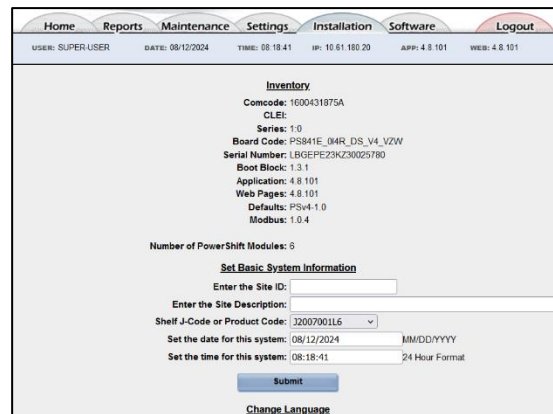
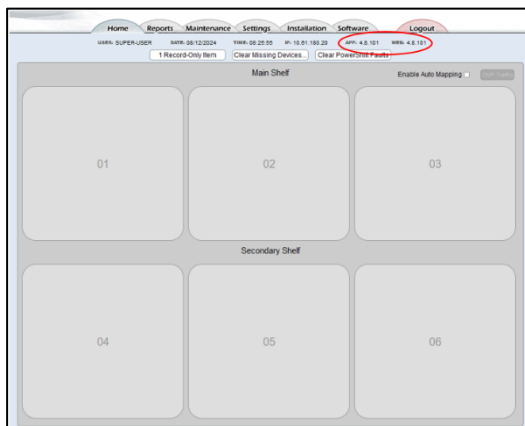

- 7) If it is required to disable a Controller communication port for security purposes (such as HTTP), then use the following steps:
 - a) In the GUI, click on the Settings tab, then click on the Security hotlink
 - b) Under Enabled Network Ports, uncheck ports to disable them

Warning: If you uncheck "Enable HTTP" and submit the change, the port will be disabled and you will lose the GUI connection; you will then need to use HTTPS to connect (//https:192.168.2.1)

- c) Click the Submit button

Inserting Modules

- 1 Slide module partially into rack slot
- 2 press metal release tab to open front cover, slide module into rack until it stops
- 3 Close the front cover on the module to make connection and lock into place. Repeat with any remaining modules. The modules operate individually so slots may be left open for future expansion.

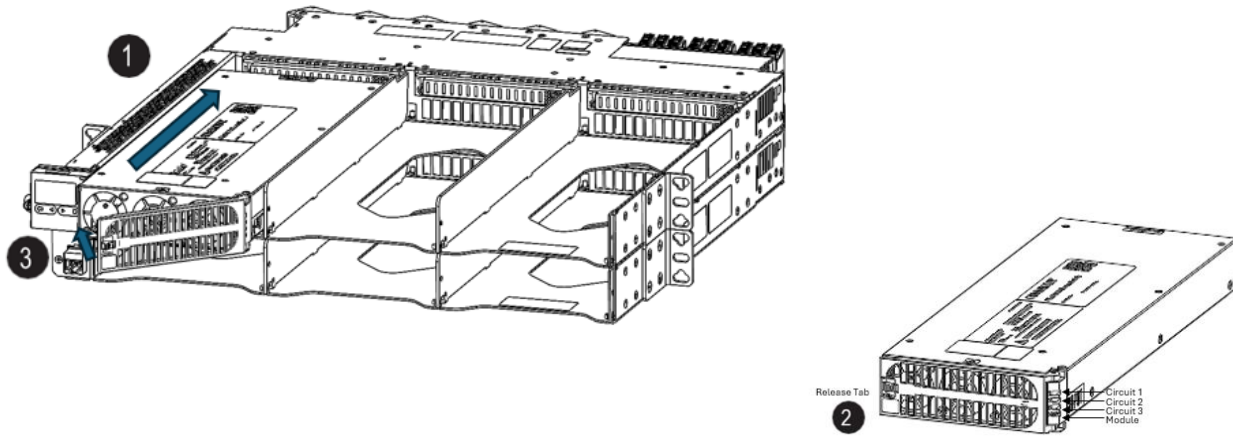

- 8) Insert a module into Shelf slot 01, the following Shelf LED behavior should occur:
 - a) Module LED (Circuit 1/Circuit 2/Circuit 3) blinks green and Module LED (Module) constant green.
 - b) After 10-30 seconds Module LED (Circuit 1/Circuit 2/Circuit 3) blinks green and Module LED (Module) constant green; this is the normal state and indicates output power is now active to the OVP base and the Module status is in Bypass.

Troubleshooting Note: If the OVP Traffic icon is red then troubleshoot as follows:

Note: If OVP Traffic icon is Gray that means it has never turned on. Enable Auto Mapping or Manually assign circuit.

- Confirm RS485 data cable is connected between PowerShift Shelf R1 port and the OVP base VBOOST OUTPUT port
- Confirm the OVP base selector switch is set to a Base Mode position 2-6

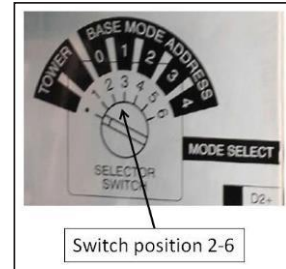

- 9) If a remote radio is connected, the radio should power on
- 10) Confirm the OVP base LED voltage display shows the lower and upper voltage measurements
 - a) On the base OVP, press the Wake/Adv button one time and release (above image is for a dome OVP, a rackmount OVP will have a different button configuration)
 - b) The display should toggle between L1 (lower voltage) and U1 (upper voltage) values
 - L1 should be 56V or higher
 - U1 will typically be 54-56V, but may be lower until the remaining steps are completed
 - Examples:

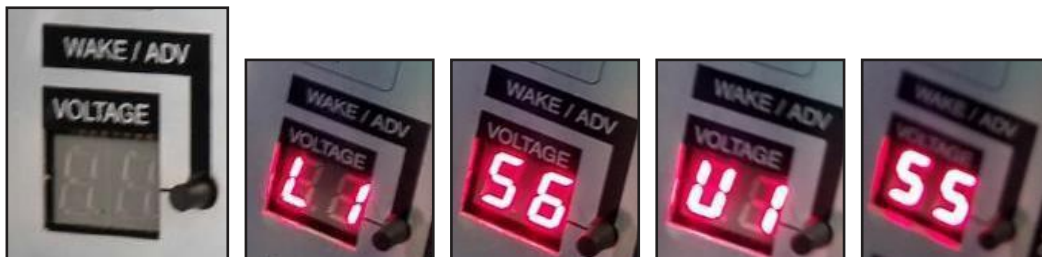

Note: See Section 13 for detailed guidance on troubleshooting Raycap OVP issues

- 11) In the PowerShift GUI Home page, confirm the circuit 01 inset box is green, indicating it has input power applied; if a radio is connected and powered on then the GUI will show the load current:

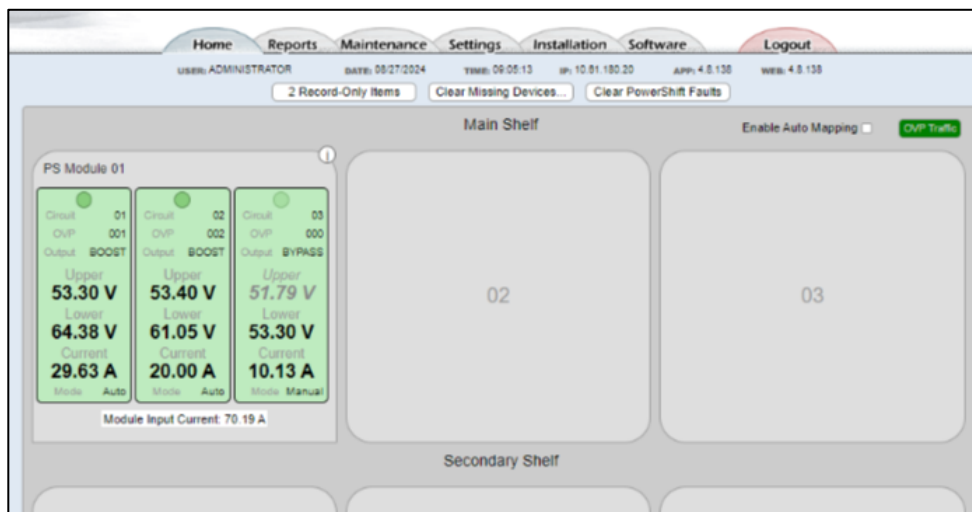

Perform OVP Circuit Assignment

12) Auto Mapping

- a) The PowerShift Shelf has the ability to automatically map circuits based on wiring and upper voltage feedback.
- b) This required the circuit to be fully wired and the modules installed. Once installed the user must "Enable Auto Mapping". This will force the circuit to be assigned based on OVP wiring.
- c) Once enabled "Assign OVP" will change to "Mapping in Progress" to "OVP XXX" depending on the mapped location.

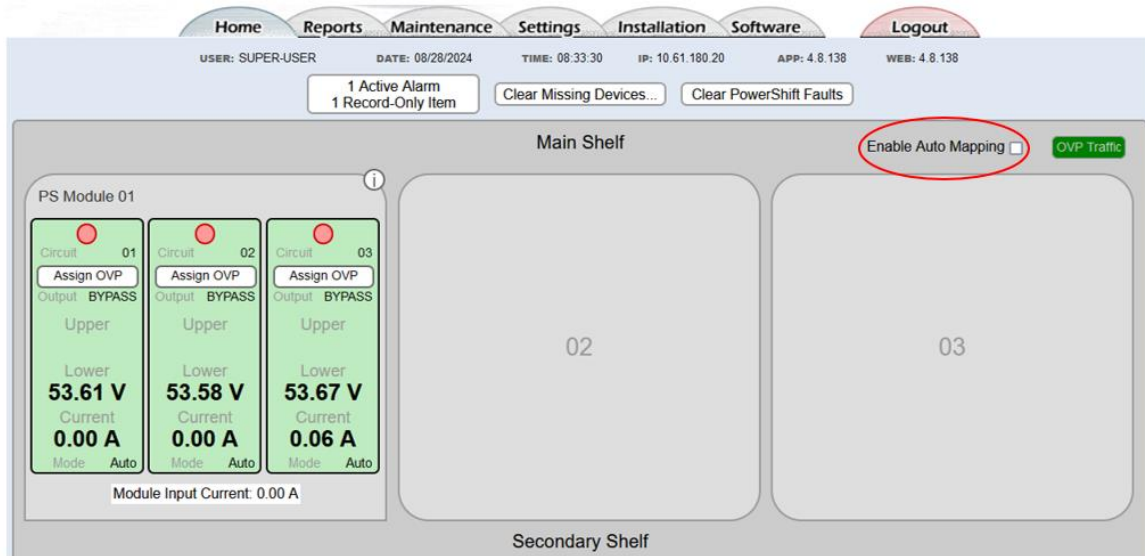

13) Manual Mapping

The following steps describe an OVP circuit assignment using the PowerShift GUI; explanation:

- a) The PowerShift Shelf is receiving the upper voltage measurement from the OVP base
- b) This next step assigns that measurement to the applicable Shelf circuit (Circuit 01 in this case)
- c) Once the assignment is made, PowerShift will adjust its output voltage based on the upper measurement voltage reported by the OVP

14) In the GUI Home page, the OVP circuit assignments are made by clicking anywhere inside the circuit box

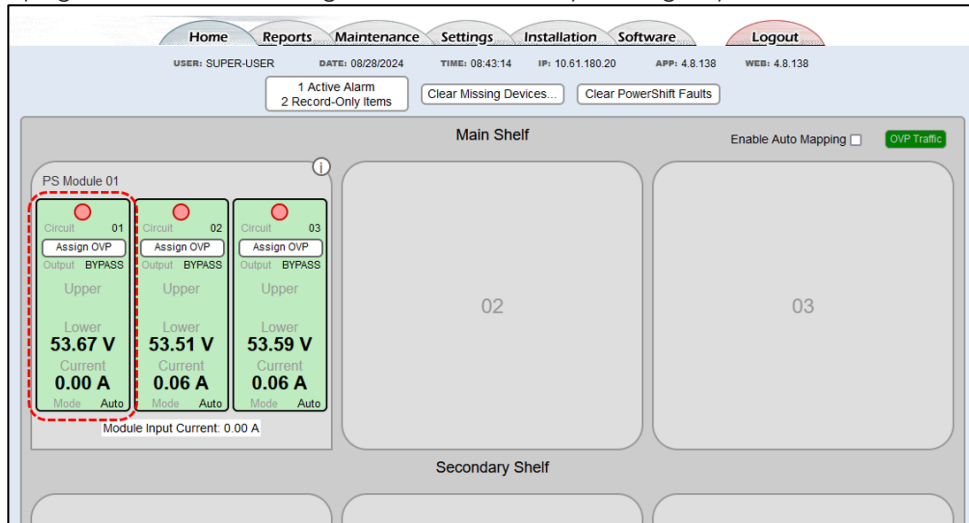

15) The circuit information pop-up box is displayed; the annotated labels describe the circuit information provided

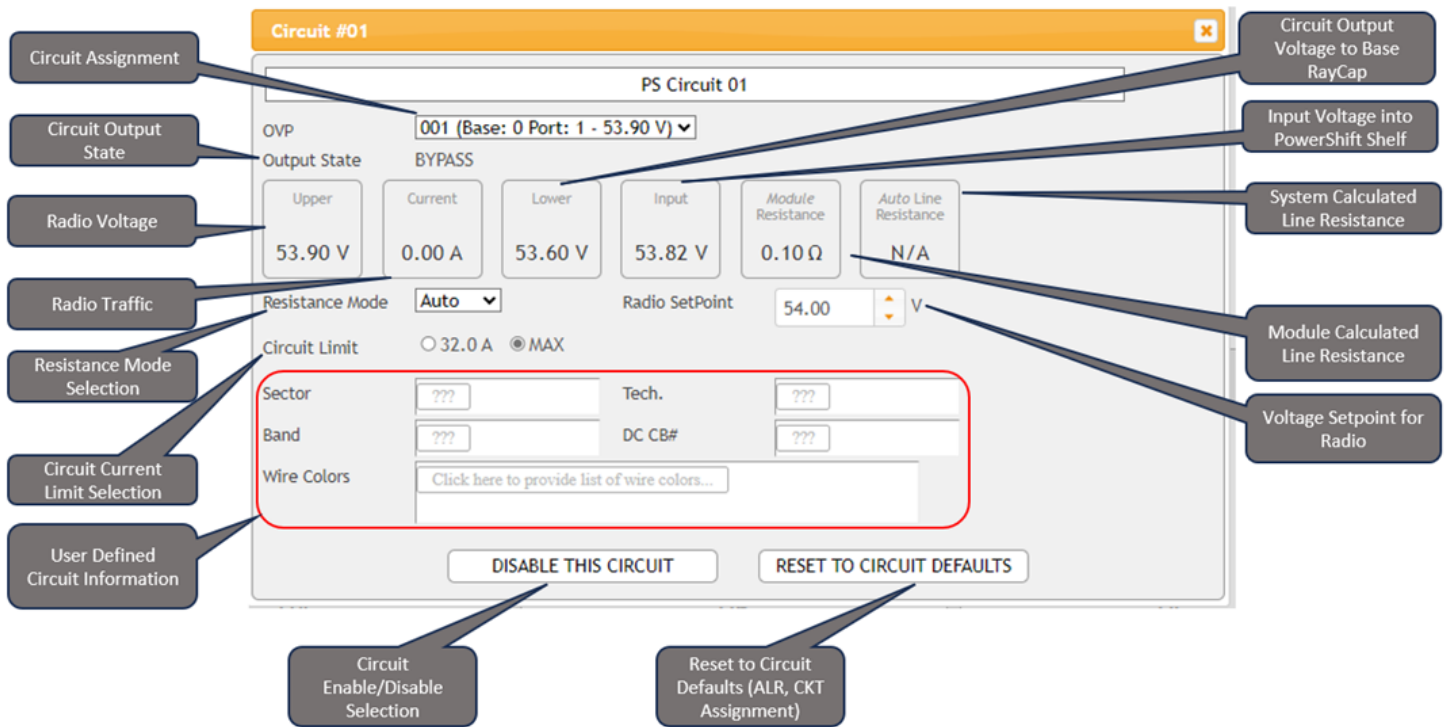

- 16) Click on the OVP Assignment box to display the list of available OVP upper voltage measurements; note the following using the example below:
- “Base: 0” is the address of the OVP base unit that receives the upper voltage measurement and sends it to the PowerShift shelf
 - “Port: 1” identifies the port number of the OVP top unit that sends the upper voltage measurement to the OVP base unit

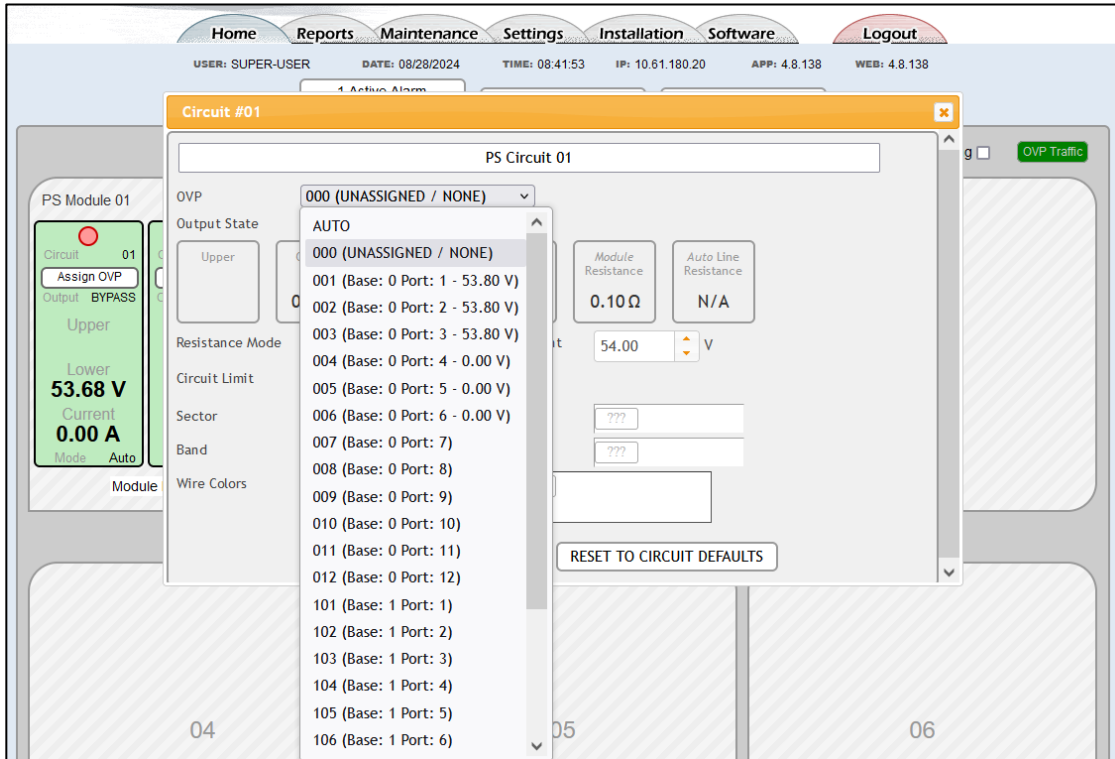

- 17) Select the applicable OVP assignment from the list
 - a) Scroll down the list as needed to find and click on the desired OVP base ID and port number
 - b) Click the "X" in the upper right corner to close the OVP assignment box and return to the Home page

- 18) Check LCD Display to confirm the Upper Voltage measurement is displayed; following is an example after assignments are made for Circuit 01 thru 03 for Module 1.



Note: The LCD main screen displays the upper voltage measurements for each module followed by each circuit after the upper voltage has been assigned to a Shelf circuit. The voltages are displayed in a 4x3 grid; example:

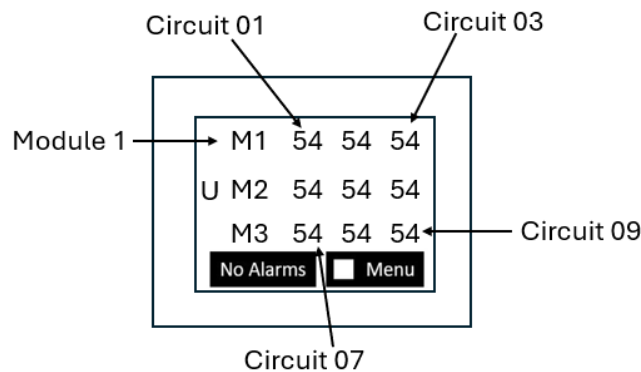

Perform Measurement Sanity Check

- 19) Using the GUI, perform a sanity check on the detailed circuit measurements using the following guidelines:
 - a) Input Voltage: Roughly equal to DC plant rectifier float voltage; typically about 54.0V to 54.5V
 - b) Lower Voltage: Around 56V or higher; the longer the trunk cable and greater the radio power demand, the greater the voltage (e.g. ~65V for 1500W RRU load and 500ft of 6-AWG)
 - c) Upper Voltage: 53.5 +/- 3V
 - d) Output Current: Greater than 0; exact value will vary significantly depending on radio model and user traffic demand
 - e) Auto Line Resistance: Varies depending on cable length and gauge; very general guideline is between 0.10 and 0.20 (may be higher for very long cable lengths and/or lighter cable gauge)

Enter Radio Information

20) In the GUI circuit pop-up box, enter the radio information (sector, technology, band) and enter the ID for the DC plant circuit breaker that provides input power to the shelf. A color code for the trunk cable can also be entered.

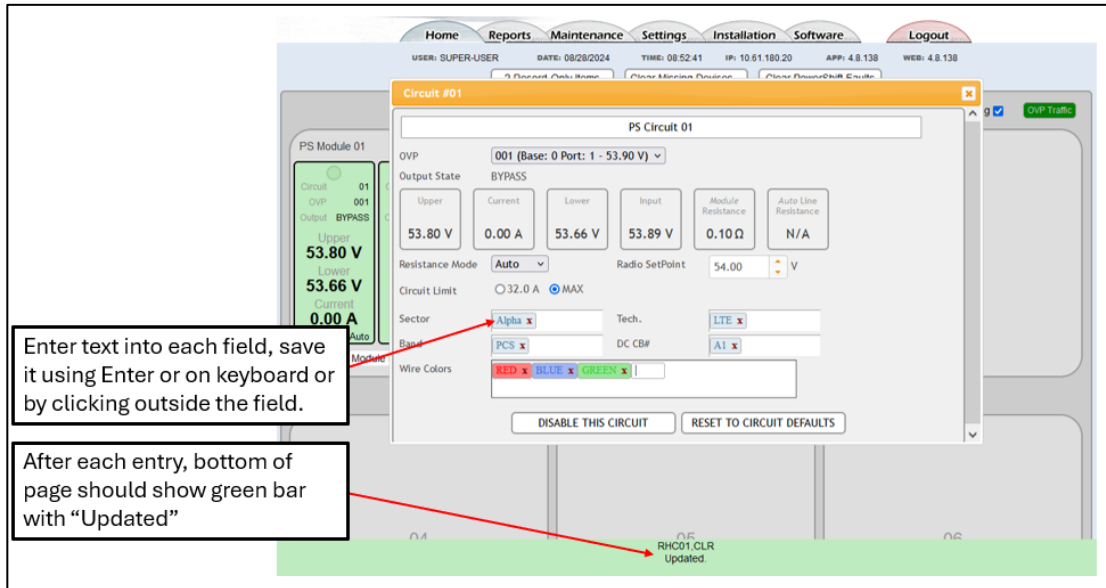

Power Up Remaining Circuits

21) Repeat the previous steps for each circuit, one circuit at a time:

- Turn on the circuit breaker
- Insert additional module as needed
- Confirm the OVP base displays lower and upper voltage measurements
- Perform the OVPRM circuit assignment
- Confirm the LCD Display shows the circuit measurements
- Perform sanity check on circuit measurements
- Insert additional Module as needed
- Enter the radio information for the circuit into the GUI

Disabling a Circuit

- 22) In some cases there will be one circuit in a PowerShift module that is powered, but the second and/or third circuit is unpowered (no radio is installed on the circuit)
- 23) In this case it is necessary to disable the unpowered circuit using the GUI
- 24) In the GUI, click inside the module box of the circuit that is to be disabled (Slot 01, Circuit 01, in this example), then click on the button "Disable this Circuit"; confirm the prompt to disable the circuit

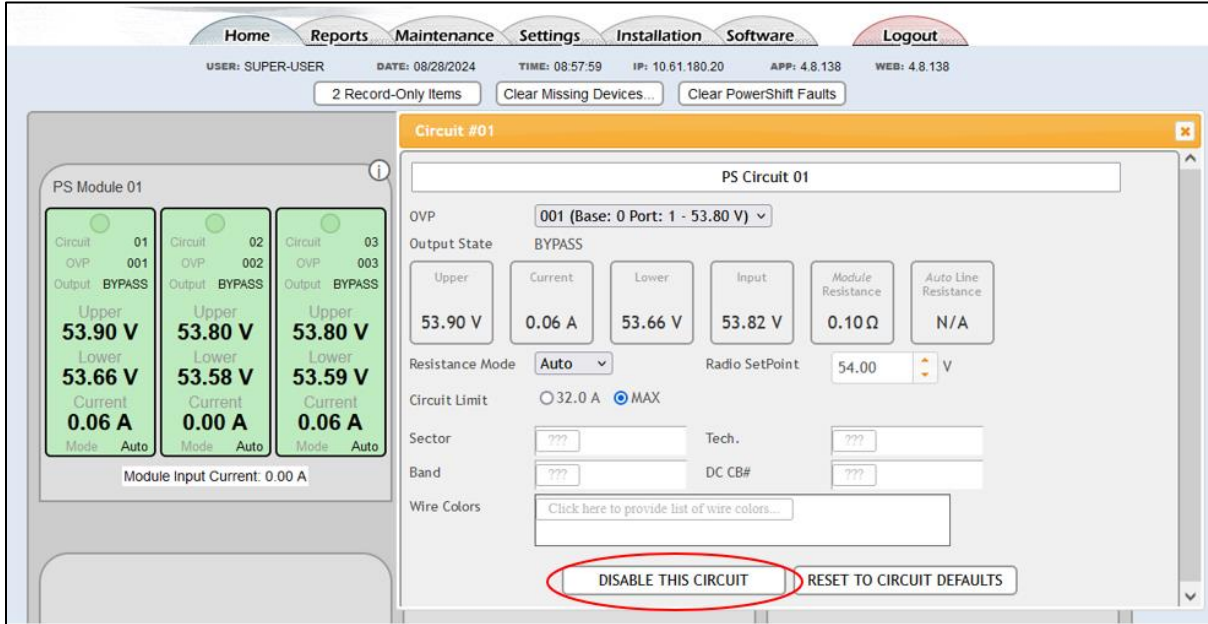

25) The GUI will show the circuit as disabled; the module LEDs for the circuit will turn off.

Note: You will be giving a prompt that "This will reset circuit settings to default! Circuit shuts down if auto-mapping is enabled."

Warning: This action will disconnect power any device connected to this circuit.

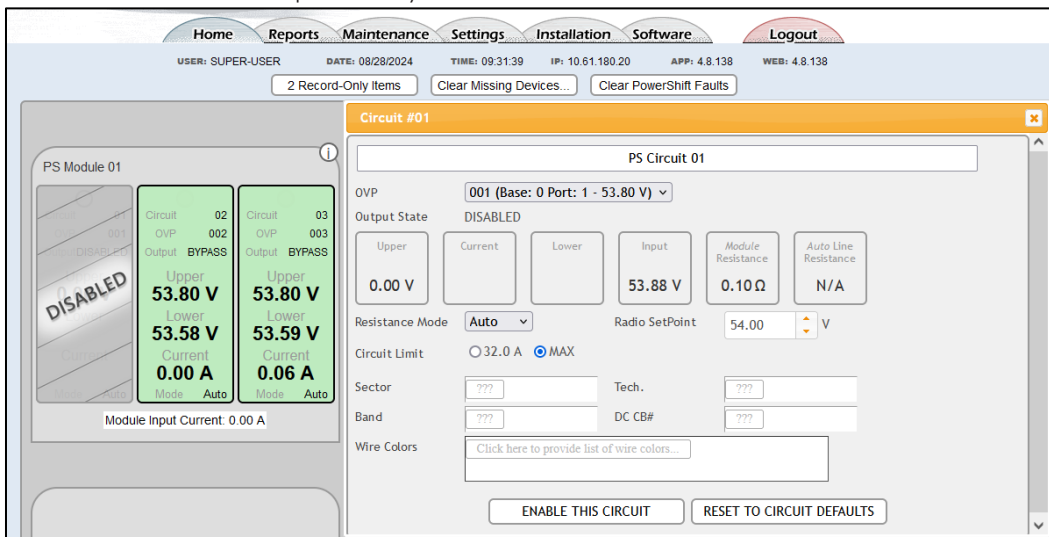

26) In order to clear the "MISSING" flag, click on the button "Clear Missing Devices"

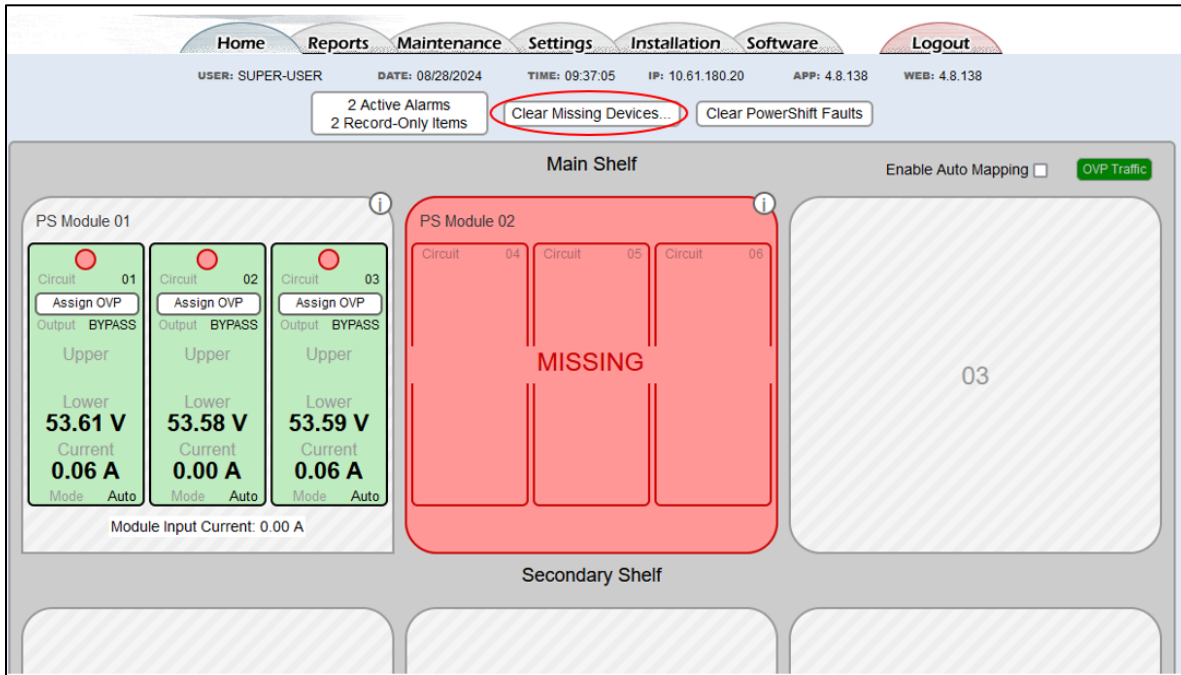

27) Summary of Main GUI



Configure Alarm Notification

28) In the GUI, click on the Settings tab, then click on the Alarm Notification link

The screenshot shows the COMMSCOPE GUI interface. At the top, there is a navigation bar with tabs: Home, Reports, Maintenance, Settings (circled in red), Installation, Software, and Logout. Below the navigation bar, the user information is displayed: USER: SUPER-USER, DATE: 08/12/2024, TIME: 08:31:28, IP: 10.61.180.20, APP: 4.8.101, and WEB: 4.8.101. The main content area contains a dialog box with the text "Please select which settings you would like to adjust:". Below this text is a table with three columns: System, Communication, and Programming. The table lists various settings, with "Alarm Notification" circled in red.

System	Communication	Programming
Date/Time/Temp	Passwords	User Defined Events
Alarm Test	Security	
PowerShift	Network	
Load Shedding	Modbus	
Part Numbers	SNMP	
	Email	
	Alarm Notification	
	UDE Notification	

29) In the Alarm Notification page, ensure the severity ("Sev.") and Relay columns are configured for each alarm section as shown in the screen captures below:

30) System Alarms

Notify Settings

Critical Equals Major

Enable Enhanced Relays

System Alarms	ID	Sev.	Relay	LED	EMAIL				SNMP				PHONE				Delay			
					1	2	3	4	1	2	3	4	1	2	3	4		O	R	N
High Ambient Temperature	AMTH1	MAJ	R2																	0s
Low Ambient Temperature	AMTL1	MAJ	R2																	0s
Config Reboot Required	CRT1	CRIT	R1																	0s
Auxiliary Major	AMJ1	CRIT	R1																	0s
Alarm Test Active	ATA1	RO																		0s
Alarm Test Aborted	ATB1	RO																		0s
Real Time Clock Battery Low	BBL1	WRN																		0s
Configuration Changed	CCH1	RO																		0s
Clock Changed	CLC1	RO																		0s
ID Conflict	DID1	CRIT																		0s
Excessive Login Attempts	EXL1	WRN																		0s
History Cleared	HCL1	RO																		0s
Password At Default	PFD1	RO																		0s
Processor Halt	PHT1	RO																		0s
Self Test Failed	STF1	MAJ	R2																	0s
ID Not Configured	ZID1	CRIT	R1																	0s

31) Communication Alarms

Communication Alarms	ID	Sev.	Relay	LED	EMAIL				SNMP				PHONE				Delay			
					1	2	3	4	1	2	3	4	1	2	3	4		O	R	N
Minor Communication Fail Alarm	CMA1	MAJ	R2																	0s
Queue Overflow	COF1	WRN																		0s
No Call-Out Response	COR1	WRN																		0s
Major Communication Fail Alarm	MCM1	CRIT	R1																	0s
Unconfigured Alarm Destination	NNC1	WRN																		0s
No Dial-Out Response	POR1	WRN																		0s
External Password Reset	EPR1	WRN																		0s

32) PowerShift Alarms

Note: Changes can be made quickly by clicking on Sev button and Relay button; for example:
 Click on the "Relay" column header and select "R1"; this will change all alarms to R1
 For alarms with MAJ severity, change the relay to "R2"

Voltage Boost Alarms	ID	Sev.	Relay	LED	EMAIL				SNMP				PHONE				Delay	
					1	2	3	4	1	2	3	4	1	2	3	4		O
Incompatible PowerShift	ICLD1	CRIT	R1															0s
OVP System H2O	TH2O1	CRIT	R1															0s
OVP System Intrusion	TINT1	CRIT	R1															0s
OVP System Power	LTP1	CRIT	R1															0s
OVP Upper Voltage Out of Range	LUV1	CRIT	R1															0s
OVP Upper to Lower Comm	TBC1	CRIT	R1															0s
PowerShift AutoResistance Fail	ARF1	MAJ	R2															0s
PowerShift Boost Over Temp	RCO1	CRIT	R1															0s
PowerShift Disabled Cct Power	LDCP1	RO																0s
PowerShift Fuse Fail	RFF1	CRIT	R1															0s
PowerShift ID Conflict	RRID1	MAJ	R2															0s
PowerShift Input Fail	RIP1	CRIT	R2															0s
PowerShift Interlock Open	RIO1	CRIT	R1															0s
PowerShift Module Mismatch	LMIS1	RO																0s
PowerShift Module Over Temp	RMT1	CRIT	R1															0s
PowerShift Multiple Fan Fail	RMF1	CRIT	R1															0s
PowerShift Output V Out of Rng	ROV1	MAJ	R2															0s
PowerShift Overload	ROL1	CRIT	R1															0s
PowerShift Primary Fault	LPRI1	CRIT	R1															0s
PowerShift Redundancy Loss	LRLS1	MAJ	R2															0s
PowerShift Resistance	LRES1	CRIT	R1															0s
PowerShift Single Fan Fail	RSF1	CRIT	R1															0s
PowerShift Translator Timeout	TPT1	CRIT	R1															0s
PowerShift Upper Voltage Low	PUVL1	MAJ	R2															0s
PowerShift Voltage Not Linked	LVNL1	CRIT	R1															0s
Manual Resistance Not Set	MRNS1	MAJ	R2															0s

Click "Relay" button to assign all to "R1", then click the alarms with "MAJ" and change to "R2"

Section 12: Closeout Package

Once the installation is complete and all alarms are cleared, use the following procedure to capture information for inclusion in the site installation closeout package

Capture the Circuit Map Worksheet

- Fill out the Circuit Map Worksheet (located on page 9)
- Obtain a photo of the completed worksheet and save it as a jpg file to your Windows PC

Capture Alarm History Report

- In the GUI, click the Maintenance tab and clear the alarm history using the “clear alarm” button (the pull-down list underneath it should be set to “Alarm”)
- Click the Reports tab, then click the Alarm History hotlink
- Click the Print Event History button to generate a pdf file, save it to your Windows PC

Capture Inventory Report

- In the GUI, click the Reports tab, then click the Inventory Report tab; it may take a minute for the report to generate
- To generate a pdf file, click the small printer icon in the upper right corner of the Inventory banner
- Important: Set the Layout to Landscape, save the pdf file to your Windows PC

Capture Home Page

- In the GUI, click on the Home tab
- Obtain a screen capture of the Home page, save it as a jpg file to your PC

Capture Circuit Pop-up Boxes

- In the GUI Home page, click on each boost module circuit to open the pop-up box
- Note that multiple pop-up boxes can be opened at the same time, they can be moved around on the page and resized as needed; this allows you to arrange at least four circuits on the page before obtaining a screen shot
- Obtain multiple screen shots as needed to capture all the boost module circuits, save them as jpg files to your Windows PC

Section 13: Troubleshooting Raycap Issues

Raycap Displays Shows 0V (example using L1/U1)

L1 voltage is 0: If Circuit 01 on the PowerShift shelf has input power and it has output voltage, then there is a possible problem with the output cabling from the PowerShift shelf to the OVP base. For example, a cross-wiring mistake where the shelf Circuit 01 output cable is connected to the wrong terminals on the OVP base

U1 voltage is 0: If the L1 voltage is not 0V, then there is a possible problem with the trunk power cables or with the twisted-pair cables between the OVP base and OVP top. Press the Wake/Adv button on the OVP base to cycle through the other measurements (L2/U2, L3/U3, etc.) to confirm they all report 0 voltage; if any non-zero voltages are observed this probably indicates a cross-wiring problem

Raycap Base OVP Alarm Condition:

The Raycap OVP base has three LEDs that illuminate red in case of an error:

- Intrusion: The top OVP cover is removed (or the intrusion micro-switch could be bad)
- H2O: The top OVP has water or high moisture content
- Power: There are several possible alarm conditions, see below

The Raycap Voltage display and the Power Alarm LED may present as one of the three scenarios shown below

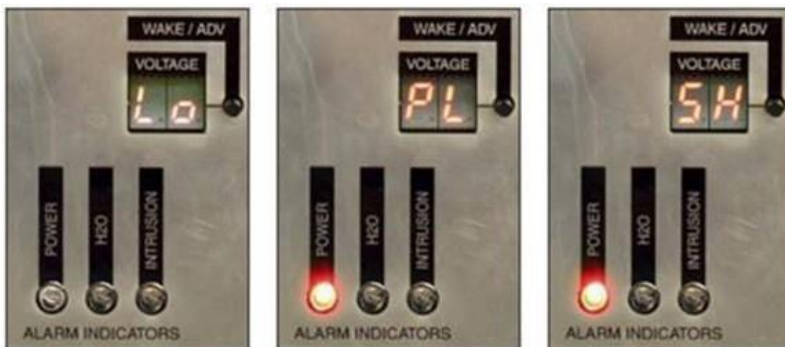

Low Voltage
(less than 35V)

Reverse Polarity

Short Circuit

General Description:

- “Lo” = Low voltage condition
(voltage at base or at top is <35V)
- “PL” = Polarity reversal condition
(the supply and return cables are swapped)
- “SH” = Short-circuit condition
(the supply and return cables are shorted together)

Following is a more detailed description of possible Power Alarm LED and Voltage display error conditions (using L1/U1 as an example):

L1 (lower)	U1 (upper)	Power Alarm LED	Possible Cause
Lo	Lo	Off	This is the expected, nominal condition for a circuit that is fully cabled but is not powered (i.e. the circuit breaker is open, or PowerShift boost and bypass modules are both not installed, or PowerShift circuit output is disabled). Note that in this configuration there will be a 30-33V is present on the circuit; it is a "sensing voltage" the Raycap OVP uses to confirm the status of an unpowered circuit.
Lo	Lo	On	Should only occur if the top OVP is a model 3315 (non-retrofit) and the sensing voltage is being dragged down to <24V (which is likely caused by an unexpected load current on the circuit).
Lo	00	-	Trunk cable pair is not connected between base and top OVPs. Or if top OVP is a model 3315 (non-retrofit) then voltmeter twisted-pair may be disconnected between base and top OVPs (see Note1 below).
Lo (or) >54V	PL	On	The trunk cable supply/return cables are swapped at the terminal block on the base OVP or on the top OVP. Or if the top OVP is a model 3315 (non-retrofit) then voltmeter twisted-pair may be swapped or disconnected (see Note1 below)
SH	SH	On	There is a short circuit between supply/return cables; could be located at base OVP terminals, top OVP terminals or somewhere within the trunk cable.
SH	00	On	Should only occur if top OVP is a model 3315; the circuit is shorted and the voltmeter twisted-pair may be disconnected between base and top OVP (see Note1 below).
>54V	Lo	Off	Should only occur if top OVP is a model 3315; the trunk supply cable may be disconnected (and the return cable is connected)
>54V	00	Off	Trunk cable pair is not connected to top OVP. Or if top OVP is a model 3315 (non-retrofit) then the trunk return cable may be disconnected (and the supply cable is connected), or the voltmeter twisted-pair may be shorted (see Note1 below).

Note: Following is the location of the terminal blocks that connect the volt meter twisted-pair

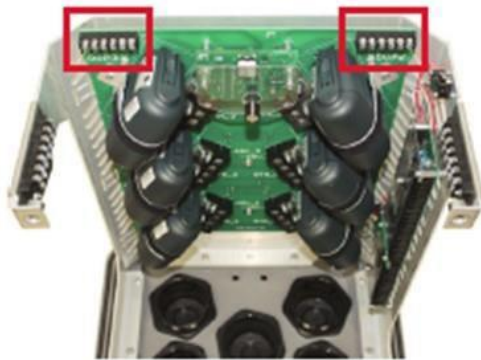

3315 OVP dome

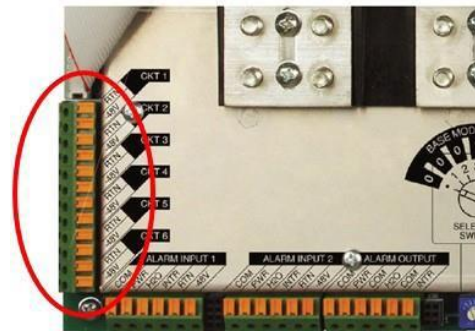

2260 Rackmount

Section 14: PowerShift Alarms and Troubleshooting

Boost and Bypass Module LEDs

There are four status indicators on each Boost module and Bypass Module: P-In, P-Out, S-In, S-Out:

- 1) P-In and P-Out represent the status of the input and output circuits (respectively) of the first circuit in a boost module or bypass module.
- 2) S-In and S-Out represent the status of the input and output circuits (respectively) of the second circuit in a boost module or bypass module.

The following table provides a summary of LED status and the corresponding operational status of the hardware.

Power and Bypass Module Operational State

	Condition	Circuit 1	Circuit 2	Circuit 3	Module
		G/Y/R	G/Y/R	G/Y/R	G/Y/R
1	All Circuits in Boost state and OK	G	G	G	G
2	Circuit 1 Boost state	G	-	-	G
3	Circuit 1 Bypass state	G Blink	-	-	G
4	Circuit 1 External Fault (e.g. Vin OV, OCP)	Y	-	-	Y Blink
5	Circuit 1 Stand-by (circuit output turned off, but circuit active on GUI)	Y Blink	-	-	G
6	Circuit 1 Internal Fault (e.g. Fuse, Vout OVP)	R	-	-	R
7	Circuit 1 Input not present, circuit 1 disabled (no circuit or any parameter tracked on GUI)	Off	-	-	G
8	Circuit 1 Thermal fault recovered, but not reset	Y Blink	-	-	Y
9	Circuit 2 Boost state	-	G	-	G
10	Circuit 2 Bypass state	-	G Blink	-	G
11	Circuit 2 External Fault (e.g. Vin OV, OCP)	-	Y	-	Y Blink
12	Circuit 2 Stand-by (circuit output turned off, but circuit active on GUI)	-	Y Blink	-	G
13	Circuit 2 Internal Fault (e.g. Fuse, Vout OVP)	-	R	-	R
14	Circuit 2 Input not present, circuit 2 disabled (no circuit or any parameter tracked on GUI)	-	Off	-	G
15	Circuit 2 Thermal fault recovered, but not reset	-	Y Blink	-	Y
16	Circuit 3 Boost state	-	-	G	G
17	Circuit 3 Bypass state	-	-	G Blink	G
18	Circuit 3 External Fault (e.g. Vin OV, OCP)	-	-	Y	Y Blink
19	Circuit 3 Stand-by (circuit output turned off, but circuit active on GUI)	-	-	Y Blink	G
20	Circuit 3 Internal Fault (e.g. Fuse, Vout OVP)	-	-	R	R
21	Circuit 3 Input not present, circuit 3 disabled (no circuit or any parameter tracked on GUI)	-	-	Off	G
22	Circuit 3 Thermal fault recovered, but not reset	-	-	Y Blink	Y
23	Defective single Fan (not immediate service needed)	-	-	-	Y
24	Any Service Creating an Internal Fault	-	-	-	R
25	Communication Fail	-	-	-	R Fast

- ¹ Normal operating state for the Boost module and Bypass module
- ² If only one module circuit has input power, the other circuit will show yellow solid on the Input LED for (boost and bypass modules); the alarm condition can be cleared by disabling the unpowered circuit in the GUI
- ³ If a boost module circuit has failed or if the boost module has been removed from the shelf, the bypass module will show green solid on the input LED and yellow solid on the output LED

The following information provides additional details and troubleshooting guidelines on the LED status

No Light

- 1) Input not present or circuit is disabled.

Green

- 1) A solid green status light indicates the circuit is functioning properly
 - a. Circuit is in Boost State and OK

Yellow

- 1) A solid yellow status light on 1, 2, or 3 - indicates the circuit has an external fault; this occurs when V_{in} overvoltage or Over-Current-Protection on that circuit.
 - b. Input voltage out of range, either $< 38\text{VDC}$ or $> 58\text{VDC}$; check output voltage at DC plant rectifier.
 - c. Short-circuit on the output cables, short-circuit or over-load condition at the RRU; the affected circuit will likely show solid green on the input and yellow wink on the output
- 2) A winking yellow status light on 1, 2, or 3 - indicates a Standby or Thermal Fault. The indicated circuit is not powered; the external fault maybe caused by the following:
 - a. Yellow may indicate a minor alarm that does not require immediate attention, but can be corrected in a service window. One example is the failure of one of the two fans in the module. The module will run, but should be replaced at earliest convenience.
- 3) After correcting the fault, the circuit can be returned to normal operation by toggling the DC plant breaker for that circuit

Red

- 1) A red winking status light on 1, 2, 3, or X - indicates an Internal Fault
 - a) During initial application of input power to the circuit (LED should change to solid green after 10-30seconds)
 - b) Whenever the controller is inserted into its slot or if it reboots (LED should change to solid green after 10-30 seconds)
 - c) The circuit input voltage is above the maximum threshold ($>58\text{VDC}$)

GUI Alarms

The following table lists all of the PowerShift alarms generated in the GUI; active alarms are viewable in the GUI Home page, and the Reports tab provides an Alarm History report.

GUI Alarm Description	Alarm Type	Severity	Relay	Description [Troubleshooting]
High Ambient Temperature	System	Major	2	Shelter/cabinet air temperature is above acceptable range
Low Ambient Temperature	System	Major	2	Shelter/cabinet air temperature is below acceptable range
Config Reboot Required	System	Critical	1	"Controller must be rebooted due to a configuration change [Reboot using GUI or reseal the controller to power cycle it]"
Auxiliary Major	System	Critical	1	N/A for PowerShift
Alarm Test Active	System	Read Only		Indicates user has initiated test of the alarm relays. True while test is active
Alarm Test Aborted	System	Read Only		User alarm test was aborted due to an actual alarm condition
Real Time Clock Battery Low	System	Warning		The lithium battery in the controller RTC should be replaced
Configuration Changed	System	Read Only		User has changed the system configuration
Clock Changed	System	Read Only		User has changed the system time/date
ID Conflict	System	Critical	1	Indicates a problem with one or more boost or bypass modules
Excessive Login Attempts	System	Warning		User has tried to login with an invalid password - three failed attempts
History Cleared	System	Read Only		User has cleared history logs for alarm history or other history logs
Password At Default	System	Read Only		The login passwords are at factory default
Processor Halt	System	Read Only		The controller processor has stopped; controller was unseated in the shelf or power is otherwise removed from the controller. Entry is written during boot up based on RTC flag
Self Test Failed	System	Major	2	N/A for PowerShift
ID Not Configured	System	Critical	1	Boost or bypass module has an ID that is outside valid range
Minor Communication Fail Alarm	Comms	Major	2	Controller has lost communication with one boost or one bypass module
Queue Overflow	Comms	Warning		N/A for PowerShift; applies only when a modem is used
No Call-Out Response	Comms	Warning		N/A for PowerShift; applies only when a modem is used
Major Communication Fail Alarm	Comms	Critical	1	Controller has lost communication with multiple boost/bypass modules
Unconfigured Alarm Destination	Comms	Warning		Alarm is configured to alert via dial-out or SNMP, but no destination has been defined
No Dial-Out Response	Comms	Warning		N/A for PowerShift; applies only when a modem is used
External Password Reset	Comms	Warning		N/A for PowerShift
Incompatible PowerShift	PowerShift	Critical	1	The controller has detected PowerShift V1 boost modules installed in the shelf; only V2 modules may be used with PowerShift V2 shelf
OVP System H2O	PowerShift	Critical	1	OVP alarm due to water ingress sensor activating on OVP dome unit
OVP System Intrusion	PowerShift	Critical	1	OVP alarm due to dome unit cover having been loosened or removed
OVP System Power	PowerShift	Critical	1	OVP alarm due to a power issue on one or more circuits
OVP Upper Voltage Out of Range	PowerShift	Critical	1	The reported radio input voltage is outside expected range (37V to 60V)
OVP Upper to Lower Comm	PowerShift	Critical	1	The OVP is reporting loss of communication between base unit and tower top unit(s)
PowerShift Auto Resistance Fail	PowerShift	Major	2	PowerShift was unable to complete a line resistance calculation for a circuit
PowerShift Boost Over Temp	PowerShift	Critical	1	"The PowerShift boost/bypass module has exceeded its operating temperature [Check for failed fan alarm on module; check the shelter or cabinet cooling system]"
PowerShift Disabled Cct Power	PowerShift	Read Only		The circuit(s) of the module have been disabled.
PowerShift Fuse Fail	PowerShift	Critical	1	The PowerShift boost converter module has a failed internal fuse; replace the module
PowerShift ID Conflict	PowerShift	Major	2	Possible issue with the PowerShift shelf unit
PowerShift Input Fail	PowerShift	Critical	1	PowerShift has lost input power to a circuit; the circuit previously had input power applied and a boost/bypass module was installed for the circuit

Cont.

GUI Alarm Description	Alarm Type	Severity	Relay #	Description [Troubleshooting]
PowerShift Interlock Open	PowerShift	Critical	1	"Boost or bypass module is improperly seated in the shelf, or the module backplane is damaged, or the shelf backplane is damaged [Reseat modules; inspect backplane of modules for any obvious dam-"
PowerShift Module Mismatch	PowerShift	Read Only		An incorrect module type has been installed. Inspect the module and confirm correct type installed.
PowerShift Module Over Temp	PowerShift	Critical	1	"The air inlet temperature to the module is above threshold temperature setpoint [Check shelter or cabinet cooling system]"
PowerShift Multiple Fan Fail	PowerShift	Critical	1	Both fans in a PowerShift boost or bypass module have failed; replace the module
PowerShift Output V Out of Rng	PowerShift	Major	2	"PowerShift boost module output voltage has exceeded the maximum output voltage of 73V [Should not occur unless module is faulted; replace the module]"
PowerShift Overload	PowerShift	Critical	1	"The output current on a PowerShift circuit has exceeded the specified maximum value of 30A, the module has turned off its output; if circuit over-current condition clears within 20 minutes, then module will re-enable output [Check for short-circuit on cable or radio; check for radio drawing excessive current]"
PowerShift Primary Fault	PowerShift	Critical	1	"A boost and bypass module pair are simultaneously trying to supply load current to a circuit [Unseat bypass module then reseat, if problem persists then swap in a different boost or bypass module to determine which module is faulted]"
PowerShift Redundancy Loss	PowerShift	Major	2	One or more PowerShift circuits has lost redundant backup power on a circuit; this can be due failure of a boost or bypass module, removal of a boost or bypass module for maintenance purposes, etc.
PowerShift Resistance	PowerShift	Critical	1	The line resistance calculated by PowerShift has a value exceeding 1 Ohms; this indicates a problem condition with the line or misapplication of the product
PowerShift Single Fan Fail	PowerShift	Critical	1	One fan in a PowerShift boost or bypass module has failed; replace the module
PowerShift Translator Timeout	PowerShift	Critical	1	"Communication failure between PowerShift shelf and OVP base unit [Check RS485 cable connection from OVP Boost Output port to PowerShift shelf R1 port]"
PowerShift Upper Voltage Low	PowerShift	Major	2	The reported radio input voltage is lower than the minimum expected voltage of 37V
PowerShift Voltage Not Linked	PowerShift	Critical	1	A PowerShift circuit has input power applied and its output power is enabled, but the GUI has not been configured to link an OVP voltage measurement to the circuit
Manual Resistance Not Set	PowerShift	Major	2	The trunk cable resistance of the circuit has not be established.

PowerShift Output Overload Protection

The boost module is designed to shut off its output circuit in the event the load demand exceeds the circuit maximum output capacity of 2708W total power (radio demand + power loss in the trunk cable)

Under normal circumstance an output overload should not occur; the proper design and installation of the PowerShift system ensures the maximum radio load demand and the trunk cable length do not exceed the circuit capacity.

However, off-nominal events such as a short in the trunk cable or a malfunctioning radio could cause the load demand to exceed the module output capacity. In this event the module functions as follows:

When circuit capacity is exceeded the module will shut off its output

The module then checks the condition of the circuit periodically (about every 5 seconds) to determine if the overload condition remains or if it has cleared

If the overload condition clears, the module will re-enable output on the circuit

If the overload condition has not cleared, the module will continue to keep the circuit output shut off and will continue to check the circuit condition about every 5 seconds

After 20 minutes, if the circuit overload condition has not cleared, the module will latch the circuit output off and will discontinue checking the circuit condition

Once the circuit is latched off, the user must intervene to re-enable it; the overload condition must be cleared and the circuit can then be re-enabled by cycling the input power breaker or by using the GUI to disable/enable the circuit

Section 15: Alarm/GP/RS485 Connectors

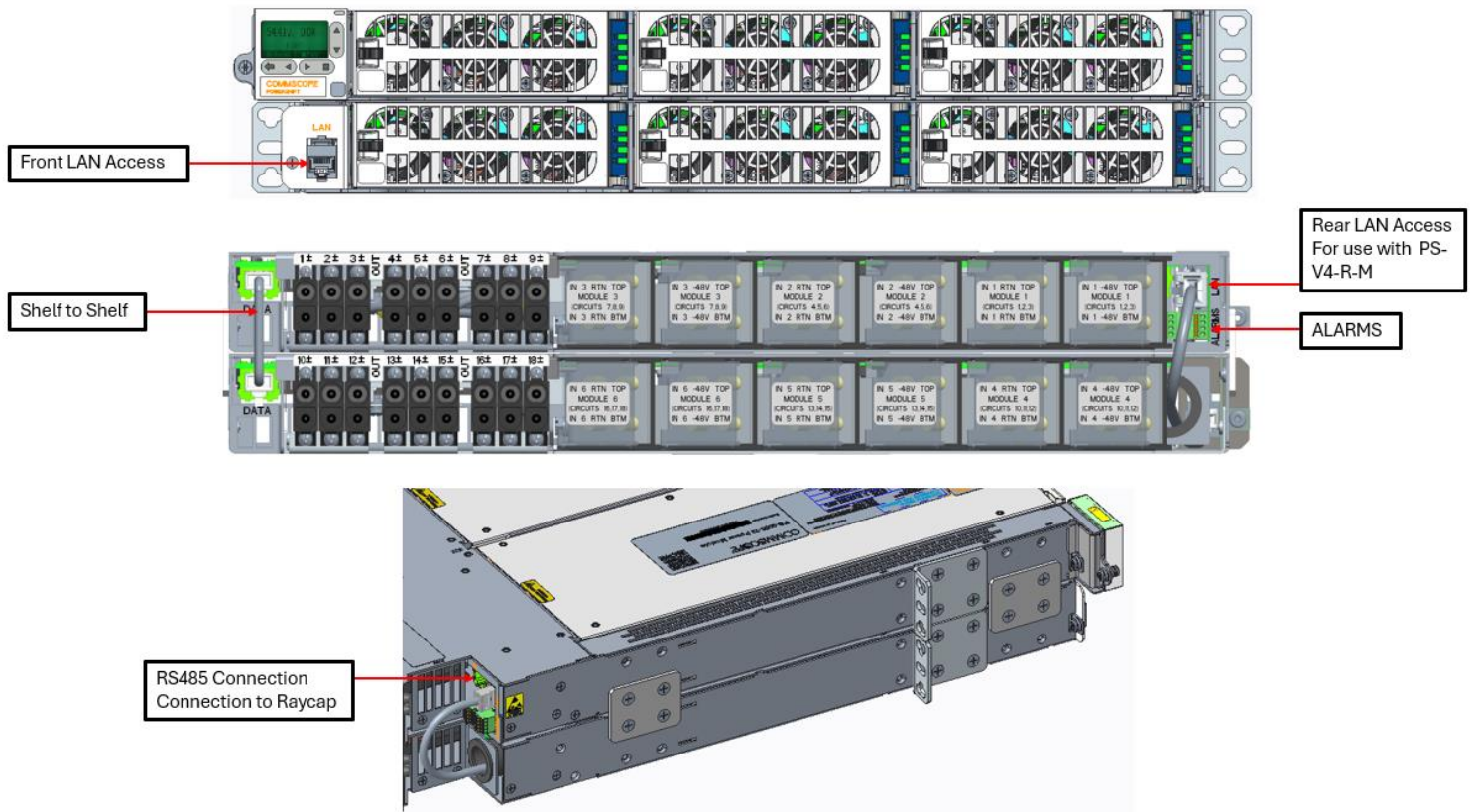

CommScope

1100 CommScope Place SE P.O. Box 339, Hickory, NC 28603-0339
 (828) 324-2200 (800) 982-1708
www.commscope.com

Customer Service 24 hours

North America: +1-800-255-1479 (toll free)
 Any country: +1-779-435-6500
 email: acicustomersupportcenter@commscope.com

Notice: CommScope disclaims any liability or responsibility for the results of improper or unsafe installation, inspection, maintenance, or removal practices.
 Aviso: CommScope no acepta ninguna obligación ni responsabilidad como resultado de prácticas incorrectas o peligrosas de instalación, inspección, mantenimiento o retiro.
 Avis: CommScope décline toute responsabilité pour les conséquences de procédures d'installation, d'inspection, d'entretien ou de retrait incorrectes ou dangereuses.
 Hinweis: CommScope lehnt jede Haftung oder Verantwortung für Schäden ab, die aufgrund unsachgemäßer Installation, Überprüfung, Wartung oder Demontage auftreten.
 Atenção: A CommScope abdica do direito de toda responsabilidade pelos resultados de práticas inadequadas e sem segurança de instalação, inspeção, manutenção ou remoção.
 Avvertenza: CommScope declina eventuali responsabilità derivanti dall'esecuzione di procedure di installazione, ispezione, manutenzione e smontaggio improprie o poco sicure.
 注意: CommScope 公司申明對於不恰當或不安全的安裝、檢驗、維修或拆卸操作所導致的後果不負任何義務和責任
 © 2018 CommScope