



FACT® Fiber Optic High Density Patch Chassis, gray, 4E high, 288-port, singlemode, holding 8 hinged trays (2 per Element) loaded with LC adapterpacks to be used with 1.2 mm simplex patch cords

- Designed for use with the all-purpose all-front-access FACT frames and FIST-GR3 frames supporting up to 2,688 LC or 1,344 SC connections in a single frame (FACT-IC frame 2880 LC or 1440 SC)
- Reduced installation and maintenance time via the toolless snap-on design supporting both interconnect and cross-connect applications
- Flexible customization enabled by 4 chassis types (patch-only, patch-splice, pre-cabled and splice-only) to support all ODF applications
- High density through the single FACT element height (1E) being 30% less tall compared to the industry standard panel height (1HU)

Product Classification

Regional Availability	Asia Australia/New Zealand EMEA Latin America North America
Portfolio	CommScope®
Product Type	Fiber patch chassis
Product Brand	FACT®
Product Series	FACT

General Specifications

Functionality	Patching
Application	Compatible with FACT frames Compatible with FIST-GR3-R frames when backplate is used (optional)
Body Style	Symmetrical
Color	Gray
Growth Configuration	Fully loaded
Patch Cord Routing	Left sided Right sided
Rack Type	FACT
Rack Units	2.8
Shelf Movement	Sliding
Total Ports, quantity	288
Transmission Standards	ETSI EN 300 019-1-3 IEC 61300-3-30

Dimensions

760253210 | FACT-4EPATHDLCS

Height	123.8 mm 4.874 in
Width	524 mm 20.63 in
Depth	283 mm 11.142 in

Ordering Tree

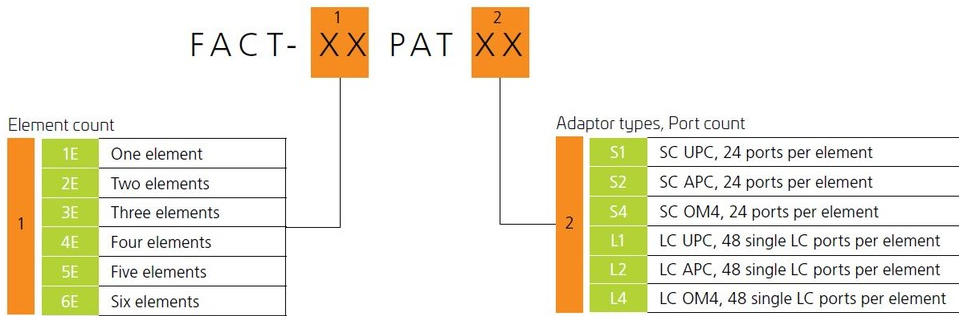

Optical Specifications

Fiber Mode Singlemode

Environmental Specifications

Operating Temperature -40 °C to +70 °C (-40 °F to +158 °F)

Storage Temperature -20 °C to +85 °C (-4 °F to +176 °F)

Flammability Rating UL 94 V-0

Packaging and Weights

Included Mounting hardware for FACT frame

Packaging quantity 1