



FACT® Fiber Optic High Density Patch Chassis, gray, 2E high, 72-port, singlemode, holding 4 hinged trays (2 per Element) loaded with SC adapterpacks

- Designed for use with the all-purpose all-front-access FACT frames and FIST-GR3 frames supporting up to 2,688 LC or 1,344 SC connections in a single frame (FACT-IC frame 2880 LC or 1440 SC)
- Reduced installation and maintenance time via the toolless snap-on design supporting both interconnect and cross-connect applications
- Flexible customization enabled by 4 chassis types (patch-only, patch-splice, pre-cabled and splice-only) to support all ODF applications
- High density through the single FACT element height (1E) being 30% less tall compared to the industry standard panel height (1HU)

Product Classification

Regional Availability	Asia Australia/New Zealand EMEA Latin America North America
Portfolio	CommScope®
Product Type	Fiber patch chassis
Product Brand	FACT®
Product Series	FACT

General Specifications

Functionality	Patching
Application	Compatible with FACT frames Compatible with FIST-GR3-R frames when backplate is used (optional)
Body Style	Symmetrical
Color	Gray
Growth Configuration	Fully loaded
Interface, front	SC/APC
Patch Cord Routing	Left sided Right sided
Rack Type	FACT
Rack Units	1.4
Shelf Movement	Sliding
Total Ports, quantity	72
Transmission Standards	ETSI EN 300 019-1-3 IEC 61300-3-30

760253214 | FACT-2EPATHDSC

Dimensions

Height	61.9 mm 2.437 in
Width	524 mm 20.63 in
Depth	283 mm 11.142 in

Ordering Tree

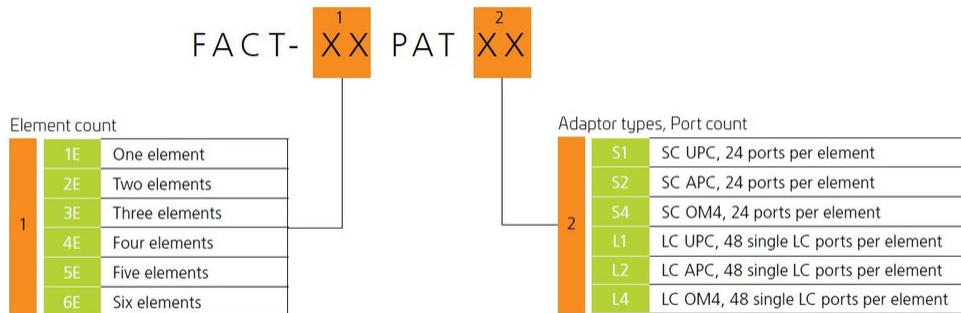

Optical Specifications

Fiber Mode Singlemode

Environmental Specifications

Operating Temperature -40 °C to +70 °C (-40 °F to +158 °F)

Storage Temperature -20 °C to +85 °C (-4 °F to +176 °F)

Flammability Rating UL 94 V-0

Packaging and Weights

Included Mounting hardware for FACT frame

Packaging quantity 1