

CW8864-000 | BUDI-2S-T-02S1ES



BUDI™ Fiber Optic Wall mount Enclosure, 2 SC/UPC adapters, single element FIST splice trays for SMOUV splices

- Compact, wall mountable fiber enclosures for indoor and outdoor use
- Specifically designed for fast FTTH deployment and easy customer connection
- Available with splicing (FIST) and/or patching and/or splitter combinations
- Multiple and modular wrap around cable port sealing options

Product Classification

Regional Availability	EMEA
Product Type	Fiber wall box
Product Brand	BUDI™
Product Series	BUDI-2S

General Specifications

Functionality	Patching Splicing
Access	Front
Enclosure Color	Gray
Front Cover Type	Snap-on cover
Interface	SC/UPC
Mounting	Wall
Port, quantity	2
Splice Tray Construction	SE (Single element)
Splicing Capacity, maximum	2

Dimensions

Height	260 mm 10.236 in
Height, with cover	285 mm 11.22 in
Width	155 mm 6.102 in
Depth	60 mm 2.362 in

Dimension Drawing

CW8864-000 | BUDI-2S-T-02S1ES

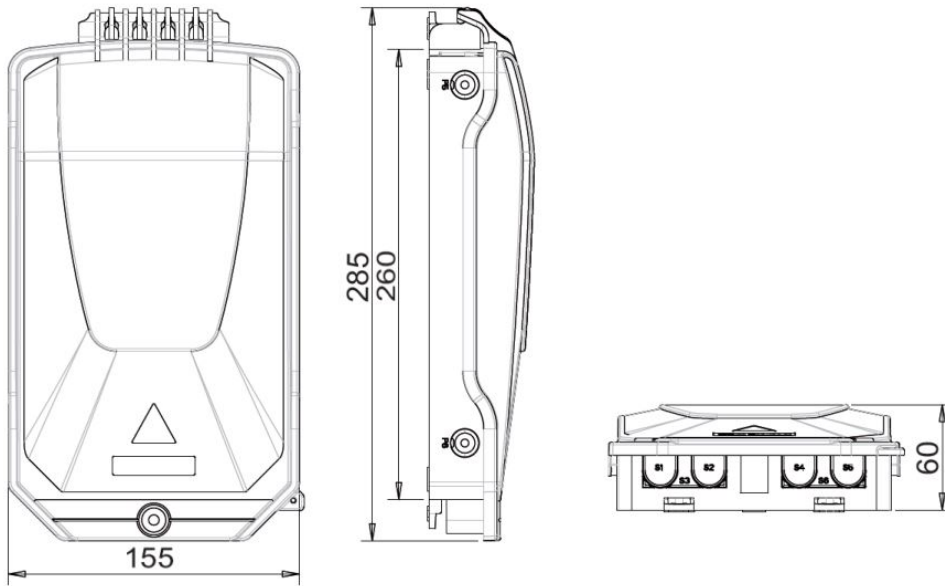

Material Specifications

Enclosure Material Type LSZH thermoplastic

Optical Specifications

Fiber Mode Singlemode

Environmental Specifications

Environmental Space Indoor/Outdoor

Qualification Standards IEC 60529, IP54 | IEC 61753-1, category G

Packaging and Weights

Packaging quantity 1

Packaging Type Box | Carton

Regulatory Compliance/Certifications

Agency	Classification
CHINA-ROHS	Above maximum concentration value
ROHS	Compliant/Exempted
UK-ROHS	Compliant/Exempted



