

RDT-SM12J00P1229A

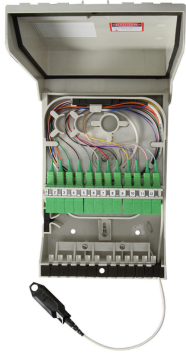

RapidFiber® Mini-RDT Distribution Terminal, 12-fiber, SC/APC, plenum cable, 400 ft

- Designed to provide a quick and simple solution for installing fiber in small and medium sized MDU's
- Incorporates a unique fiber cable spooling system that stores up fiber cable within the enclosure
- Removes the need for field termination and extensive site survey inspections

Product Classification

Regional Availability	North America
Product Type	Fiber distribution terminal
Product Brand	RapidFiber®
Product Series	Mini-RDT

General Specifications

Adapters, quantity	12
Cable Entry Location	Bottom left Bottom right
Cable Type	Plenum - Stranded
Color	Gray
Interface	SC/APC
Interface, stub	MPO
Mounting	Wall
Port, quantity	12

Dimensions

Height	200 mm 7.874 in
Width	140 mm 5.512 in
Depth	60 mm 2.362 in
Cable Length	121.92 m 400 ft
Outer Cable Diameter	3 mm 0.118 in

Dimension Drawing

RDT-SM12J00P1229A

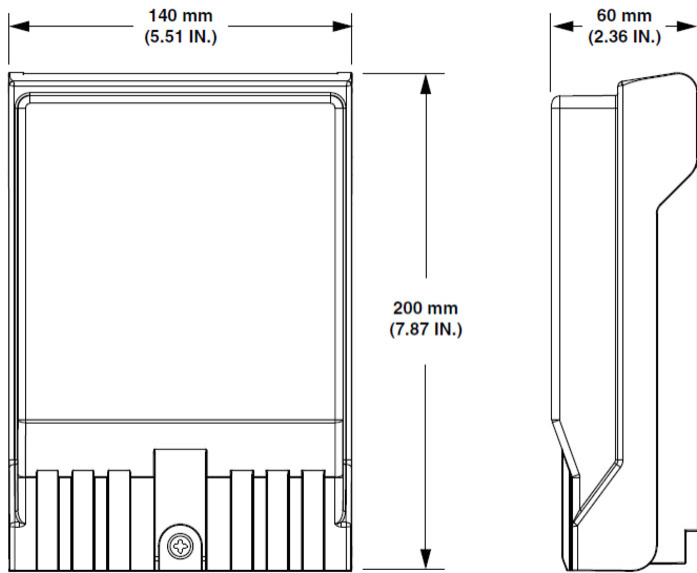

Ordering Tree

RDT - S M XX X 0 0 X XXX X X

Enclosure type

M 12 Fiber plastic

Cable count

04 4
08 8
12 12

Connector type

J SC/APC
K LC/UPC
L LC/APC
N SC/UPC

Cable type

D Indoor/outdoor 3.6mm black
P 3mm loose tube ivory plenum (zipcord for 24 fibers)

Stubbed end configuration

A MPO connector
O No connector

Fanout

1 SC/UPC
2 SC/APC
3 LC/UPC
4 LC/APC

Enclosure end configuration

9 900µm - standard

Cable Length (Plenum)

030	30 meters (100')
061	61 meters (200')
092	92 meters (300')
122	122 meters (400')
152	152 meters (500')
183	183 meters (600')

Cable Length (Indoor/Outdoor)

015	15 meters (50')
030	30 meters (100')
045	45 meters (150')
061	61 meters (200')
076	76 meters (250')
092	92 meters (300')
107	107 meters (350')
122	122 meters (400')
137	137 meters (450')
152	152 meters (500')
168	168 meters (550')
183	183 meters (600')
198	198 meters (650')

RDT-SM12J00P1229A

Material Specifications

Material Type Plastic

Optical Specifications

Fiber Mode Singlemode

Environmental Specifications

Environmental Space Indoor

Packaging and Weights

Packaging quantity 1

Regulatory Compliance/Certifications

Agency	Classification
CHINA-ROHS	Above maximum concentration value
REACH-SVHC	Compliant as per SVHC revision on www.commscope.com/ProductCompliance
ROHS	Compliant/Exempted
UK-ROHS	Compliant/Exempted

