

MST-08XX00-A0050UM



DLX® Mini-MST, Fiber Optic Multiport Service Terminal, 8-port, dielect. flat loose tube cable, 50 m

- Hardened connectors are factory-terminated and environmentally sealed for use in optical drop cable deployments
- Plug and play adapter ports ensure rapid cable installment in the outside plant access section of the network
- Multiport Service Terminals incorporate hardened connector technology that is designed to withstand the rugged outside plant environment

Product Classification

| | |
|-------------------------------|---------------------------------------|
| Regional Availability | Asia Latin America North America |
| Product Type | Access terminal, without splitter/tap |
| Product Brand | DLX® |
| Product Series | Mini-MST |
| Minimum Order Quantity | 2 |

General Specifications

| | |
|---------------------------|-------------------------------------|
| Cable Type | Dielectric - Flat - Loose Tube |
| Cable, quantity | 1 |
| Distribution Type | 8 ports |
| Enclosure Color | Black |
| Mounting | Handhole Pedestal Pole Strand |
| Port Type | Hardened mini-size DLX |
| Port, quantity | 8 |
| Splitter, quantity | 0 |
| Stub Type | Stub tail |

Dimensions

| | |
|-----------------------------|-------------------------------|
| Height | 298 mm 11.732 in |
| Width | 130.3 mm 5.13 in |
| Depth | 89 mm 3.504 in |
| Cable Length, stub | 165 ft (50 m) |
| Cable Outer Diameter | 4.5 x 8.1 mm (0.18 x 0.32 in) |

MST-08XX00-A0050UM

Dimension Drawing

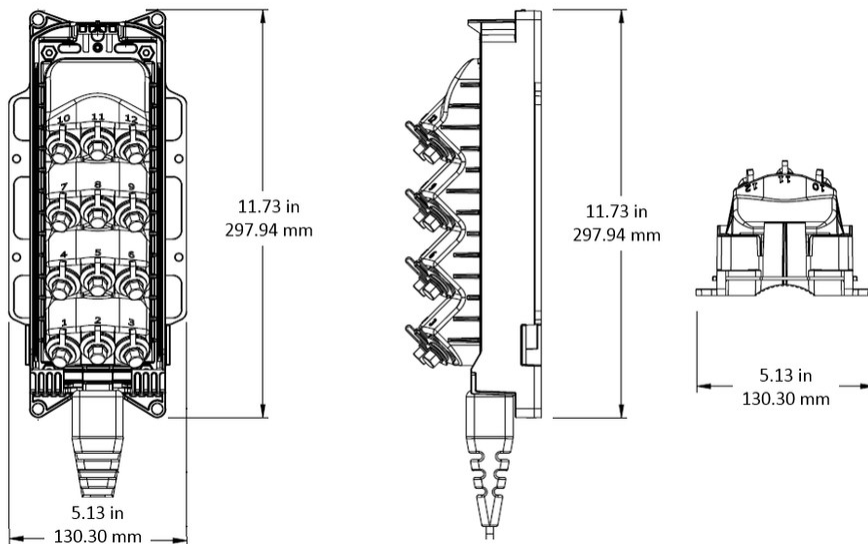

Ordering Tree

MST - X X -

Terminal model

| | |
|----|----------------|
| 02 | 2 ports |
| 04 | 4 ports |
| 06 | 6 ports |
| 08 | 8 ports |
| 12 | 12 ports |
| 0N | 1 x 4 splitter |
| 0J | 1 x 8 splitter |
| 0W | 1 x 2 splitter |

Cable termination

| | |
|----|--|
| 00 | Pigtail (No connector) |
| X0 | DLX connector (only available on splitter terminals) |

Cable type

| | |
|---|---|
| A | Dielectric, flat, loose tube (44.3mm x 8.0mm) |
| B | Locatable/tonable, flat, loose tube (44.3mm x 10.0mm) |

Mounting style*

| | |
|---|--|
| U | Universal: Terminal is on top of the spool; stub deploys first |
| A | Reversal Spool: Terminal is on the bottom of the spool; terminal deploys first |

*0-300 ft lengths of cable is automatically coiled (option U), for lengths greater than 300 feet choose U or A option.

Standard cable stub length

| | | | |
|------|----------|------|------------|
| 0050 | 50 feet | 1000 | 1,000 feet |
| 0100 | 100 feet | 1250 | 1,250 feet |
| 0250 | 250 feet | 1500 | 1,500 feet |
| 0500 | 500 feet | 1750 | 1,750 feet |
| 0750 | 750 feet | 2000 | 2,000 feet |

Standard lengths shown; metric lengths available

Material Specifications

Enclosure Material Type

Gasketed hardened plastic

Optical Specifications

Fiber Type

G.657.A1/A2

MST-08XX00-A0050UM

| | |
|--|---|
| Operating Wavelength Range | 1260 – 1635 nm |
| Attenuation Cable Coefficient, maximum | 0.30 dB/km @ 1550 nm 0.40 dB/km @ 1310 nm |
| Attenuation Terminal Connectors, maximum | 0.4 dB |
| Directivity, minimum | 60 dB |
| Insertion Loss, Terminal Connector, typical | 0.16 dB |
| Return Loss, Connector, minimum | 65 dB |

Environmental Specifications

| | |
|--------------------------------|--|
| Operating Temperature | -40 °C to +70 °C (-40 °F to +158 °F) |
| Relative Humidity | 5%–100%, condensing |
| Environmental Space | Above ground Below ground Buried |
| Flammability Rating | UL 94 V-0 |
| Qualification Standards | IEC 60529, IP68 + 2 m waterhead Telcordia GR-3120-CORE Telcordia GR-326-CORE Telcordia GR-771-CORE |
| UV Resistance | UV stabilized |

Packaging and Weights

| | |
|------------------------------|--|
| Included | Enclosure (1) Universal mounting bracket (1) |
| Packaging quantity | 1 |
| Packaging Type | Box Carton |
| Weight, without cable | 0.99 kg 2.183 lb |

Regulatory Compliance/Certifications

| Agency | Classification |
|---------------|--|
| CHINA-ROHS | Below maximum concentration value |
| ISO 9001:2015 | Designed, manufactured and/or distributed under this quality management system |
| REACH-SVHC | Compliant as per SVHC revision on www.commscope.com/ProductCompliance |
| ROHS | Compliant |
| UK-ROHS | Compliant |



Included Products

MST-UMB-MINI – DLX® Mini-MST, Fiber Optic Universal Mounting

MST-08XX00-A0050UM

Bracket