

**45x45 OUTLET, SINGLE/DUAL PORT for AMP-TWIST*, 110 and SL- Series Jacks
P/N 336793-X**

1.- PRODUCT DESCRIPTION

This 45x45 single/dual outlet is designed to accept AMP NETCONNECT* SL-Series connectors, AMP-TWIST Jacks and 110 Jacks. Figure 1 shows the exploded view of the installation kit.

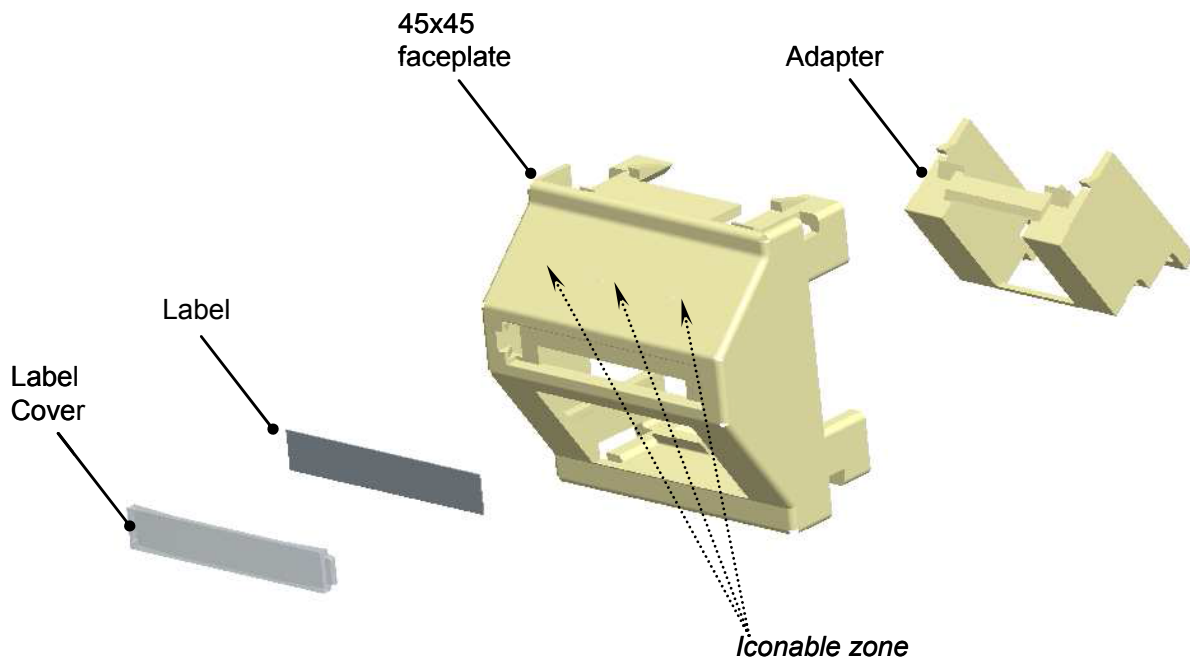

Figure 1

NOTE

SL-Series connectors are not included in the kits. SL Series blank inserts are included in kits. (Views are only for reference).

2.- REFERENCE DOCUMENTS

AMP NETCONNECT customer drawings are available from the service network. The information contained in the customer drawing takes priority if there is any conflict with this specification or with any other technical documentation supplied by AMP NETCONNECT.

3.- DESCRIPTION

Each 45x45 application Outlet consists of:

- 45x45 faceplate.
- Adapter for single applications.
- Label.
- Label cover.

3.1 Compatibility with field applications:

- Legrand 45x45 Mosaic™ system and mounting methods.
- It can be installed in trunks or in wall-box applications.

3.2 Compatible with: Refer to below table:

| Connector type: | Category | Shield | Dust Cover | Instruction sheet (See Note) | CommScope PN | View (for ref. only) |
|-----------------|----------|--------|------------|------------------------------|--------------------------|---|
| SL, Tool-less | 5e | Yes | No | 408-4542 | 1339015-X |  |
| | 5e | No | No | 408-4542 | 1116604-X |  |
| | 5e | No | Yes | 408-4542 | 1339189-X |  |
| No SL, 110 | 5e | No | No | 408-3389 | 406372-X |  |
| | 5e | Yes | No | 408-4537 | 1116515-1 |  |
| SL, 110 | 6 | Yes | No | 408-8858/ 408-8602 | 1375188-X |  |
| | 6 | No | No | 408-8858/ 408-8417 | 1375055-X |  |
| SL, AMP-TWIST | 6 | Yes | Yes / No | 411-93007 | 1711160-X / 1711342-X |  |
| | 6A | Yes | Yes / No | 411-93016 | 1711592-X/ 1711716-X |  |
| | 7A | Yes | Yes / No | 411-93013 | 1711441-X/ 1711437-X |  |

| SL aux. component: | Commscope PN | View |
|--------------------|--------------|---|
| Blank insert | 1116412-X |  |

NOTE



For connectors termination procedures, refer to Instruction sheet related to each jack type.

3.3 Material/Color:

- Faceplate adapter: Polycarbonate according to RAL 9010 (White).
- Label cover: Polycarbonate- transparent.

3.4 Packaging: According to CommScope packaging spec. 107-22048.

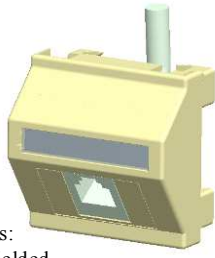
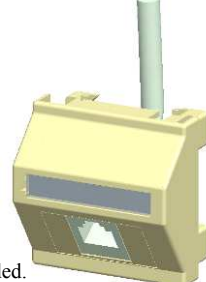
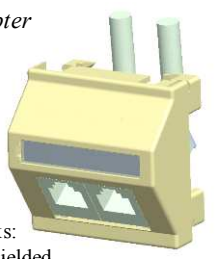
3.5 Mounting Options: Refer to below table.

| | |
|---|---|
| <p><i>With adapter</i></p>  <p>1 SL-Series jacks: • Shielded/Unshielded. • Dust cover (with and w/o)</p> | <p><i>With adapter</i></p>  <p>1 110 Mod. Jack: • Shielded/Unshielded.</p> |
| <p><i>Without adapter</i></p>  <p>2 SL-Series jacks: • Shielded/Unshielded. • Dust cover (with and w/o)</p> | <p><i>Without adapter</i></p>  <p>SL-Series jack + Blank insert • Shielded/Unshielded. • Dust cover (with and w/o)</p> |

4.- MOUNTING PROCESS (for connector and blank insert)

Follow next steps in order to assembly the connectors (or blank insert).

NOTE

*If only 1 connector is required, to cover the uncovered space using the adapter is necessary.
If 2 connectors are required, it is not necessary to use neither the adapter nor the blank insert.*

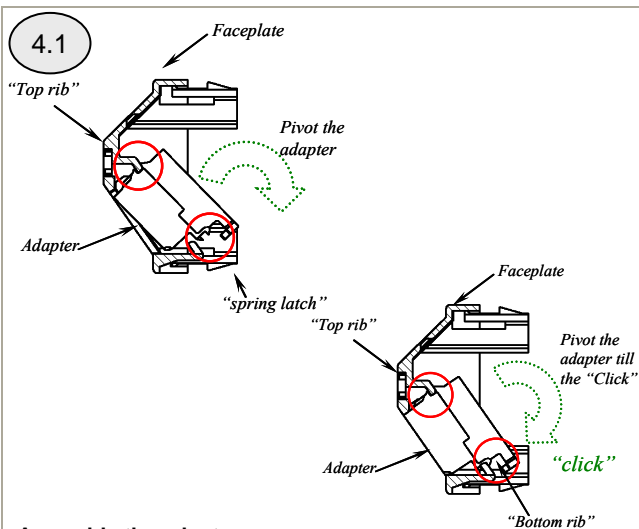

Assembly the adapter:

- Lock the adapter by pushing the top slot against the top rib of the faceplate.
- Pivot the adapter while pushing it towards the top, to allow the spring latch to enter into the bottom rib.

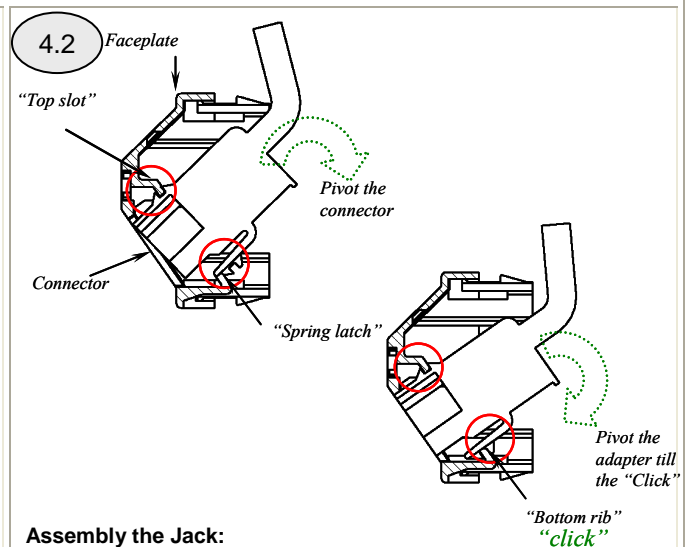

Assembly the Jack:

- Lock the jack by pushing the top slot against the top rib of the faceplate.
- Pivot the jack while pushing it towards the top, to allow the spring latch to enter into the bottom rib.
- When 2 jacks are required (not using adapter), do it 2 times.

5.- COMPLEMENTARY PROCEDURES.

5.1

Connector

Screwdriver

Extraction procedure for Jack:
Unlock the connector spring latch as shown.

5.2

Connector

Screwdriver

Extraction procedure for adapter:
Unlock the adapter spring latches as shown.

5.3

Icon (see note)

Flat object

45x45 faceplate

Label Cover

Pivot Label cover fixing in label holder

Label Cover

Label

Iconable zone

- Assembly of label and label cover. Assembly of icon holes.

NOTE Additional color coding of the ports can be done by using icons (PN 558176-X, 558198-X and 558199-X)

5.4

Flat object

- Extraction of label cover.

6.- INSTALLATION & REMOVAL PROCEDURE (Wall box)

6.1

Mosaic™ Mounting plate

Spring latch (x4)

- Place the wall box in free zone (at least 150 mm per each side) avoiding edges and obstructions.
- Cut-off the cable, leaving a small excess (not more 100/120 mm.).
- Install outlet [faceplate + adapter (if required)] into mounting plate. (Refer to 6.1).
- Terminate the connectors according to Instruction Sheet.
- Mounting of the required connectors (SL, 110 or AMP-TWIST) into the faceplate (Refer to 4.1 and 4.2).
- Place Outlet into wall box, taking care of cable bending.

6.2

Unlock the 4 spring latches

Removing Outlet from a wall box.

- Extract the plastic frame (not included in kit) and remove the mounting plate plus outlet assy.
- By means of a screwdriver, push on the 4 slots. (refer to 6.2).
- Disengage and extract the outlet from the mounting plate.
- Extract the connectors from faceplate (refer to 5.1).

7.- REVISION SUMMARY:

Revision A: Initial release of doc.
Revision B: Document updated with views and New Logos
Revision C: Document rebranded to CommScope.