

# Installation Instructions



Bulletin 237309 Revision E Page 1 of 2

## N Connectors

for HELIAX® LDF4-50A Coaxial Cable

Andrew Institute offers installation training.

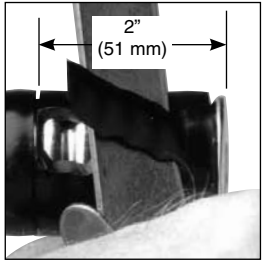
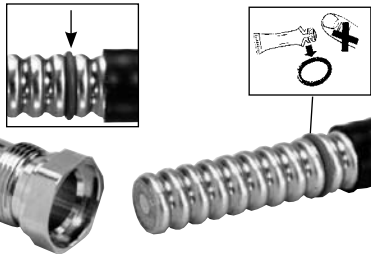
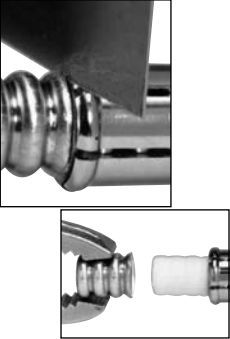
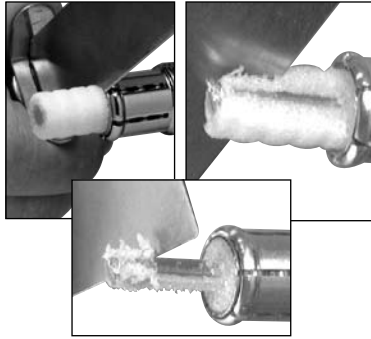
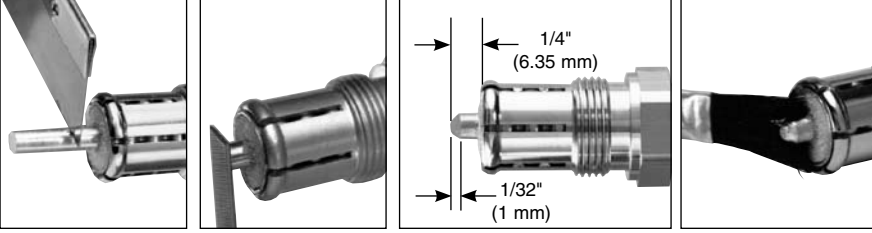
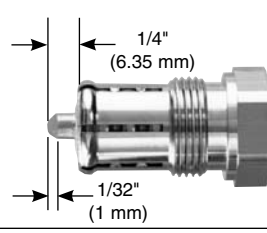
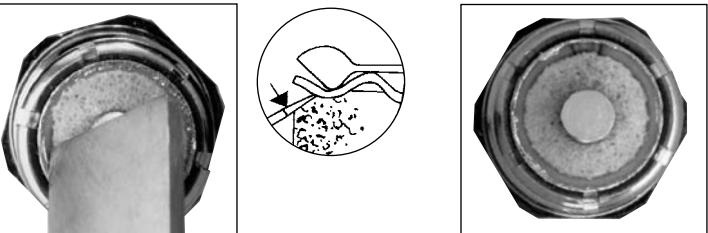
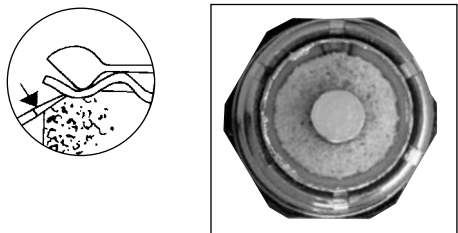

<p><b>1</b></p> <p>Trim cable jacket. Recortar la envuelta del cable. Coupez la gaine du câble. Kabelmantel abziehen. Retire a capa do cabo. 切整電纜外皮</p> 	<p><b>2</b></p> <p>Add O-ring, grease, and clamping nut. Añadir la junta tórica, la grasa y la tuerca sujetadora. Mettez en place le joint torique, de la graisse et l'écrou de serrage. O-Ring und Klemmutter vor Montage einfetten. Coloque o anel O ring, graxa e a porca de aperto. 加O型圈，油脂和緊固螺母</p> 
<p><b>3</b></p> <p>Cut outer conductor. Cortar el conductor externo. Coupez le conducteur extérieur. Außenleiter zurückschneiden. Corte o condutor externo. 切外導體</p> 	<p><b>4</b></p> <p>Remove foam and adhesive. Retirar el material de espuma y el adhesivo. Enlevez la mousse et l'adhésif. Verschäumung und Klebeband entfernen. Remova a espuma e o adesivo. 去除泡沫塑料和粘潔劑</p> 
<p><b>5</b></p> <p>Trim inner conductor. Remove debris. Cortar el conductor interno. Retirar los restos. Coupez le conducteur intérieur. Enlevez les débris. Innenleiter abschneiden. Metallspäne entfernen. Limpe o condutor interno. Remova os detritos. 切整內心導體。去除殘渣</p> 	
<p><b>6</b></p> <p>Compress foam. Comprimir el material de espuma. Comprimez la mousse. Verschäumung zusammendrücken. Comprima a espuma. 壓緊泡沫塑料</p> 	

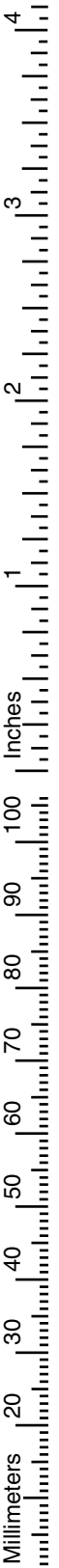

7

Flare outer conductor, examine flare, remove debris  
 Acampanar el conductor externo, examinar la forma de campana y retirar los restos.  
 Evasez le conducteur extérieur, examinez l'évasement et enlevez les débris.  
 Außenleiter aufweiten, Öffnung prüfen und Metallspäne entfernen.  
 Flangear o conductor externo, examinar o flangeamento e remover os detritos.  
 擴張外導體，檢查擴張表面，去除殘骸。

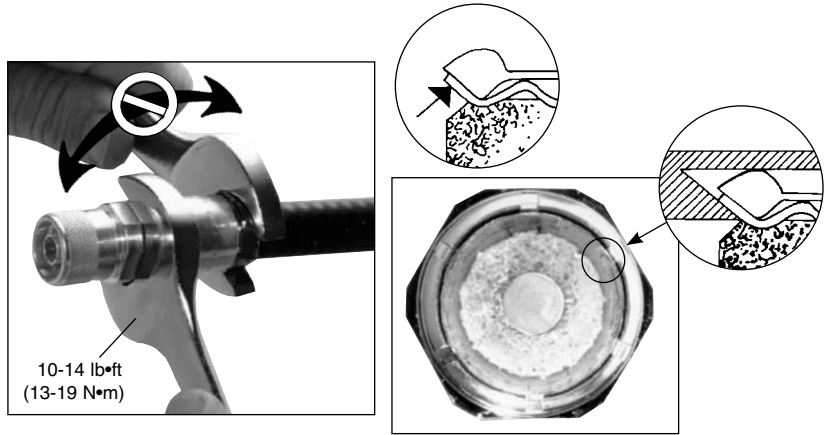

8

Add O-ring and grease. Reassemble connector.  
 Añadir la junta tórica y grasa. Montar nuevamente el conector.  
 Mettez en place le joint torique et graissez. Réassemblez le connecteur.  
 O-Ring vor Montage einfetten. Steckverbindung wieder zusammenbauen.  
 Coloque o anel em O ring e graxa. Reinstale o conector.  
 加 O 型圈和油脂。重新裝配接頭

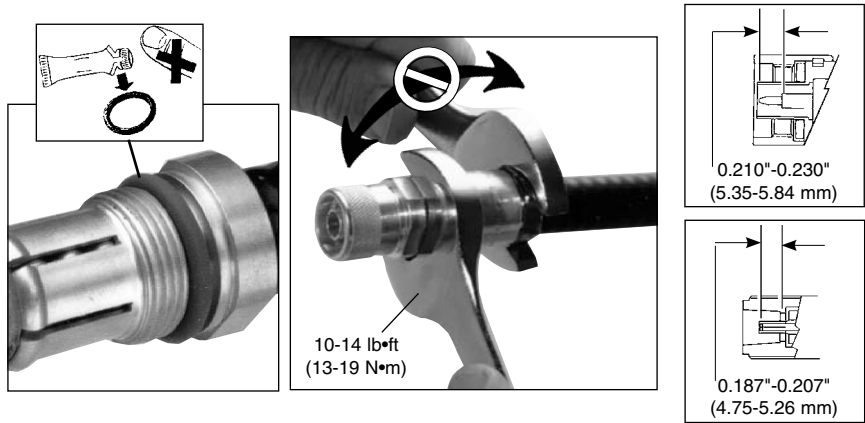

9

Coupling torque.  
 Par de acoplamiento.  
 Couple de serrage.  
 Anschlußdrehmoment.  
 Torque de conjugação.  
 配合扭矩

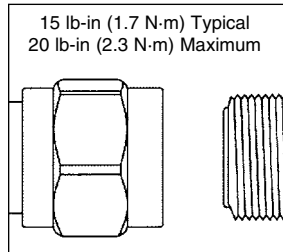

部件名称 (Part Name)	表一 有毒有害物质或元素名称及含量标识格式					
	有毒有害物质或元素					
	铅 (Pb)	汞 (Hg)	镉 (Cd)	六价铬 (Cr6+)	多溴联苯 (PBB)	多溴二苯醚 (PBDE)
连接器 (Connector)	X	O	O	O	O	O

O: 表示有毒有害物质在该部件所有的均质材料中的含量均在SJ/T 11363-2006规定的限量要求以下。  
 X: 表示该有毒有害物质至少在该部件的某一均质材料中的含量超出SJ/T 11363-2006规定的限量要求。

**Andrew Corporation**  
 3 Westbrook Corporate Center, Suite 900, Westchester, Illinois U.S.A. 60154  
 +1 (708) 349-3300 Fax (U.S.A.): 1-800-349-5444  
 www.andrew.com

**Customer Service 24 hours**  
 U.S.A., Canada, Mexico: 1-800-255-1479  
 U.K.: 0800 250055  
 Other Europe: +44 592 782 612

Notice: Andrew disclaims any liability or responsibility for the results of improper or unsafe installation, inspection, maintenance, or removal practices.  
 Aviso: Andrews no acepta ninguna obligación ni responsabilidad como resultado de prácticas incorrectas o peligrosas de instalación, inspección, mantenimiento o retiro.  
 Avis: Andrew décline toute responsabilité pour les conséquences de procédures d'installation, d'inspection, d'entretien ou de retrait incorrectes ou dangereuses.  
 Hinweis: Andrew lehnt jede Haftung oder Verantwortung für Schäden ab, die aufgrund unsachgemäßer Installation, Überprüfung, Wartung oder Demontage auftreten.  
 Atenção: A Andrew abdica do direito de toda responsabilidade pelos resultados de práticas inadequadas e sem segurança de instalação, inspeção, manutenção ou remoção.  
 Avvertenza: Andrew declina eventuali responsabilità derivanti dall'esecuzione di procedure di installazione, ispezione, manutenzione e smontaggio improprie o poco sicure.  
 注意: Andrew 公司申明對於不恰當或不安全的安裝、檢驗、維修或拆卸操作所導致的後果不負責任何義務和責任