

A997-0076 Revision F, October 2016

F-118-GL-E Mounting Kits for Multi/Single Band High Wind Panel Antenna

General

This instruction sheet contains all necessary information required to assist in the correct installation of larger Single and Multiband Panel Antennas for high wind locations requiring the use of 3 mounting points. These antennas can be supplied with either fixed beam downtilt, manually adjustable electrical downtilt or AISG-compatible remotely controlled electrical downtilt. Fixed mounting kits only are supplied for use in high wind situations.

Following symbols can be found next to text outlining important information.



Please follow the procedure marked with this symbol precisely. Non-compliance may lead to damage of the product.



Handy tips when installing product.

Unpacking

Make sure that the antenna and the accessory items listed below are provided and have not been damaged during transport.

- Antenna
- Mounting kit (mounting kit components are given on mounting assembly drawing supplied).
- Hex Key 6mm AF (supplied with adjustable downtilt antennas only).

Installation Instructions



Ensure a torque spanner is used when tightening fasteners, see the mounting kit diagrams on the following pages for the correct torque recommendations.



Ensure antenna is installed with the connectors at the bottom.



Do not install near power lines. Power lines, telephone lines, and guy wires look the same. Assume any wire or line can electrocute you.



Do not install on a wet or windy day or when lightning or thunder is in the area. Do not use metal ladder.



Wear shoes with rubber soles and heels. Wear protective clothing including a long-sleeved shirt and rubber gloves.

Installation Instructions - Fixed Downtilt Mounting Kit F-118-GL-E

Assemble three mounting kits as per Figures 2 of this document



1. Attach the mounting kit assembly to the antenna, before trying to clamp the brackets to the pole.



Clamp brackets can clamp pipe diameters between 50mm (2") & 115mm (4.5"). For high wind locations the minimum recommended pole diameter is 88mm (3.5").

Figure 1: Correctly Assembled Mounting Bracket for Fixed Downtilt Antenna

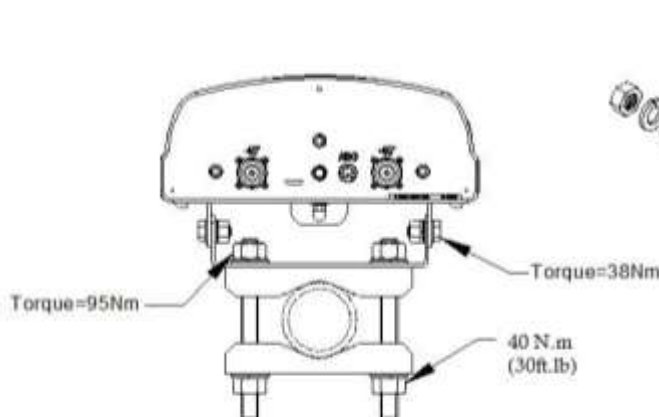

Figure 2. Fixed Downtilt Mounting Bracket Assembled to Antenna

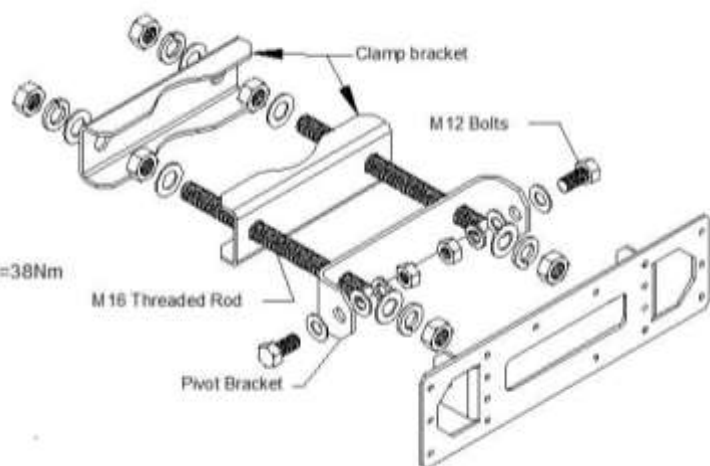

Figure 3. Fixed Downtilt Mounting Bracket Exploded Assembly

Operation of Antennas

Fixed Downtilt Antennas

The beam downtilt is factory set.

Manual Electrically Adjustable Downtilt Antennas

The beam downtilt below the horizon is by rotating the hex socket located at the bottom of the antenna (see Figure 4). Turning the hex socket in a clockwise direction increases the beam downtilt below the horizon. Turning the hex socket in an anti-clockwise direction decreases the beam downtilt below the horizon. Beam downtilt setting can be read off the scale at the base of the antenna.

AISG Compliant Adjustable Downtilt Antennas - Fitted with Remote Downtilt Adjustment

AISG Compliant antennas are compatible with AISG compliant control unit equipment. For operation of downtilt using AISG compliant controllers see the controller documentation.



WARNING: During downtilt adjustment ensure the hex socket is not turned past the minimum tilt or past the maximum tilt as shown on the downtilt indicator scale. Forcing the hex adjustment beyond this point may lead to damage of the downtilt mechanism. Using power drills and electric screwdrivers to adjust downtilt may also lead to damage of the downtilt mechanism.

Figure 4: Single Band, 7-16 Connector, slimline antenna with connections labelled

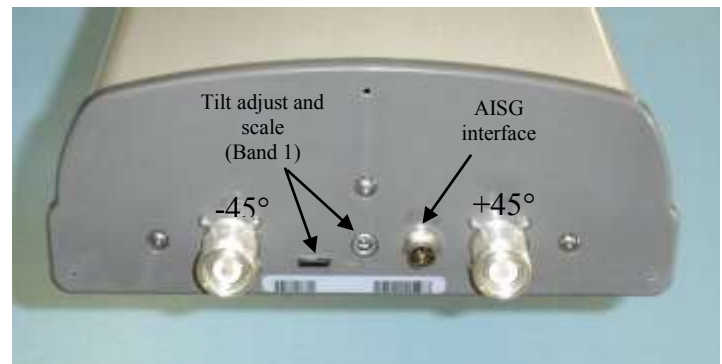
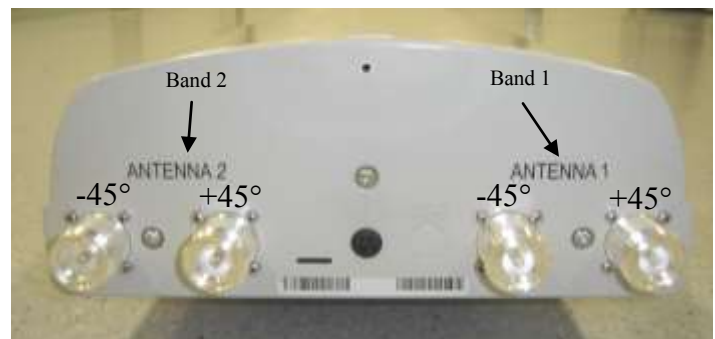

Figure 5: Dual Band, 7-16 connector, slimline antenna with connections labelled. (Fixed Tilt Antenna Pictured)



Note: The phase center of Band 2 is situated above that of Band 1.

Figure 6: Dual band, 7-16 connector, antenna with connections labelled.

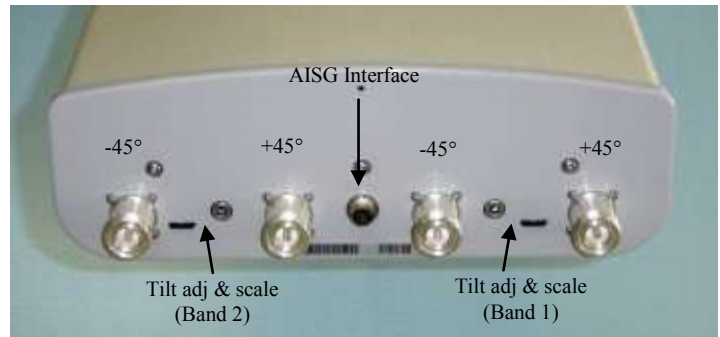

Figure 7: Diplexed dual band, 7-16 connector antenna with connections labelled.

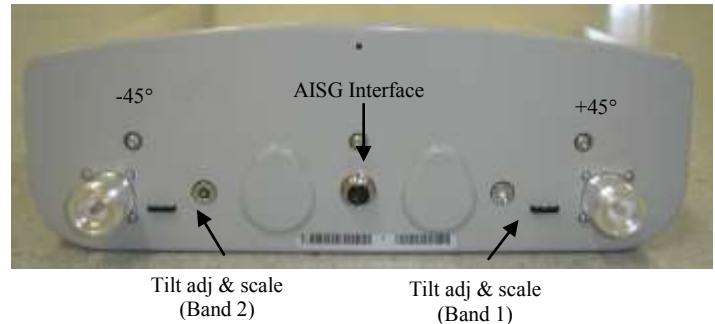
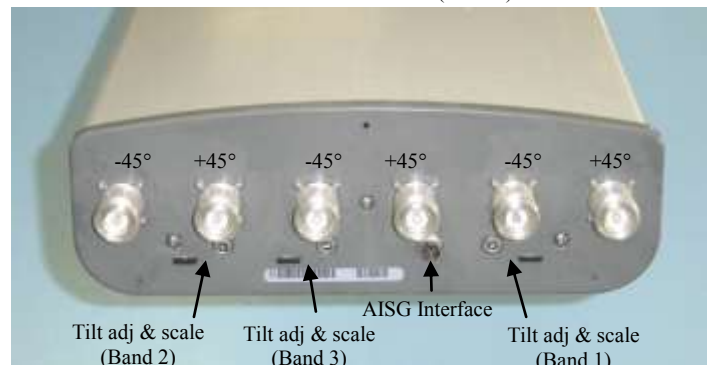
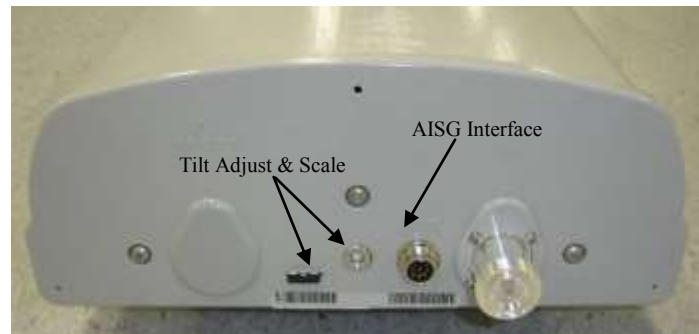

Figure 8: Tri band, 7-16 connector, antenna with connections labelled.



Note: The phase center of Band 3 is situated above that of Band 2.

Figure 9: Single band, 7-16 connector, vertically polarized slimline antenna with connections labelled.



Figures 4, 5, 6, 7 and 8 show the configuration of the positive and negative slant polarization ports for single and multi band antennas. The tilt adjuster and port for remote interface is also highlighted.

Electrically Adjustable Downtilt Antennas – Indicator Scale

The downtilt angle in degrees below the horizon is read from the angle indicator scale. The downtilt scale is read from face of the antennas base plate at the point where the scale protrudes. As the downtilt is increased, the indicator scale protrudes further past the face, revealing further graduations of degrees.

Remote Electrical Tilt Connection



The AISG connector fitted to the antenna is designed to accept any AISG compliant cable assembly. After ensuring both connectors are dry, push in the mating connector, then tighten.

Using excessive torque may damage the AISG connection in the antenna.

RF Cable Connection



The RF connectors fitted to the antenna are designed to fit jumper cables with a corresponding male connector. After ensuring both mating connectors are dry push the male connector in and tighten the connector coupling to the correct torque setting. If needed or as required by local procedures a weatherproofing kit may then be fitted to the connection.

If the RF connectors are tightened beyond the recommend torque the RF connection to the antenna may be damaged.