

- 7/16 DIN **Connector Attachment**
for HELIAX® HJ4.5-50 Coaxial Cable
- 7/16 DIN **Acoplamiento de Conectores**
para cable coaxial HELIAX HJ4.5-50
- 7/16 DIN **Montage des Connecteurs**
Pour Câbles Coaxiaux HELIAX HJ4.5-50
- 7/16 DIN **Steckermontage**
für HELIAX-Koaxialkabel HJ4.5-50

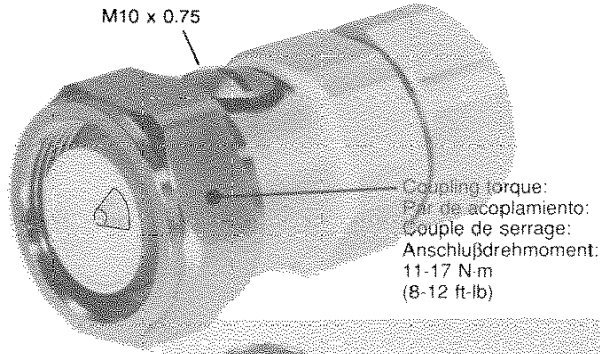

7/16 DIN male
7/16 DIN macho
7/16 DIN mâle
7/16 DIN Stecker

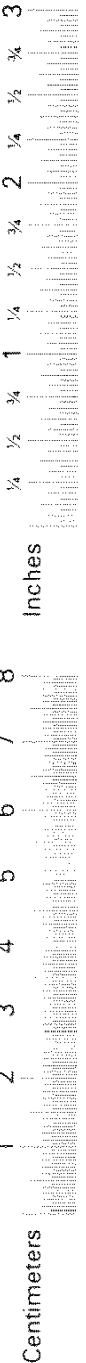

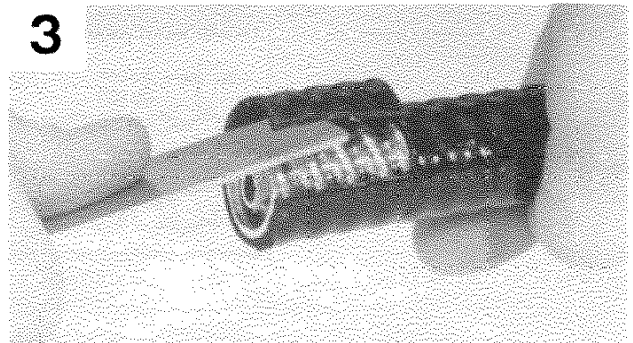
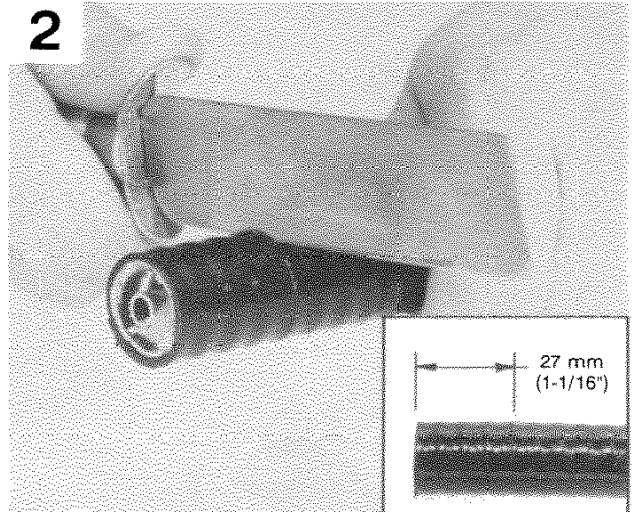
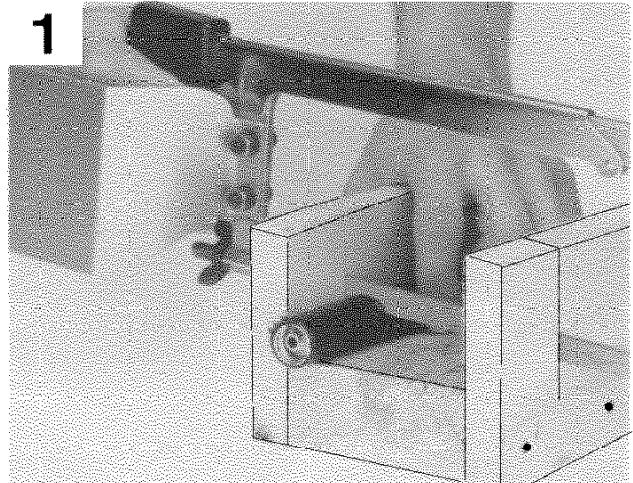
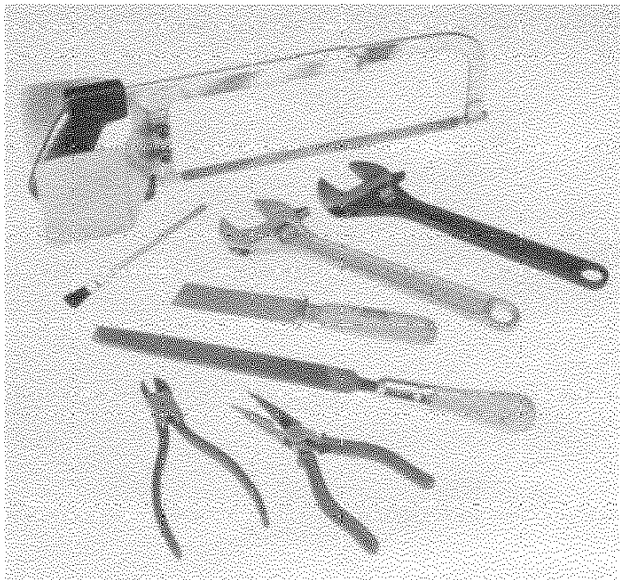
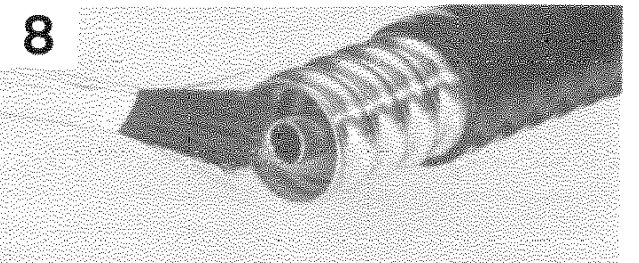
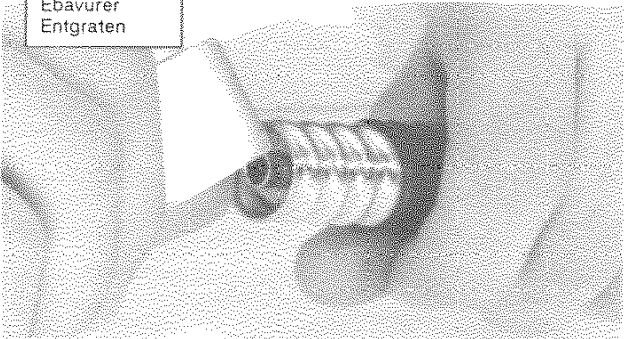
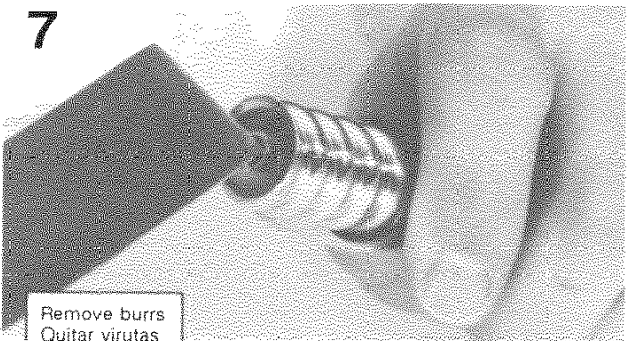
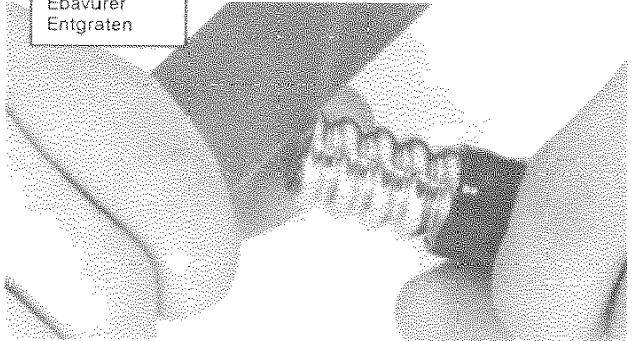
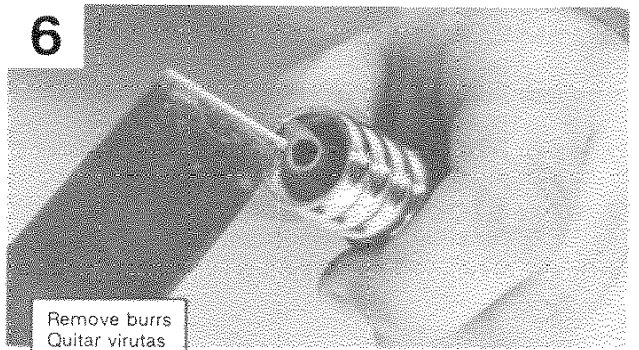
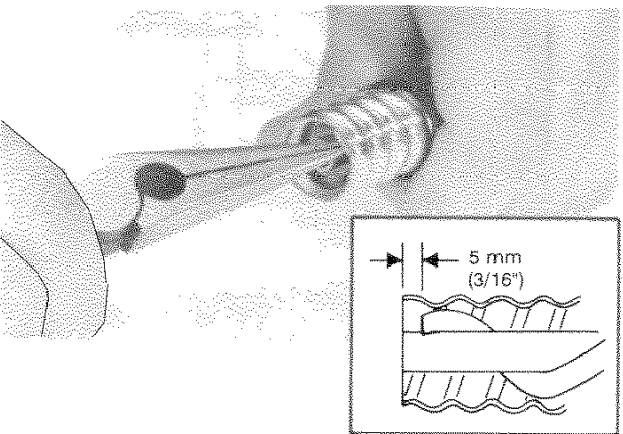
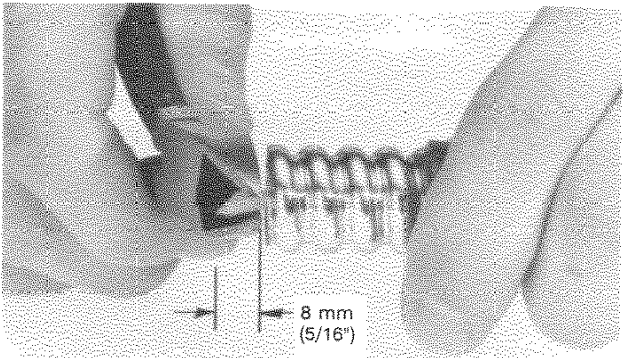
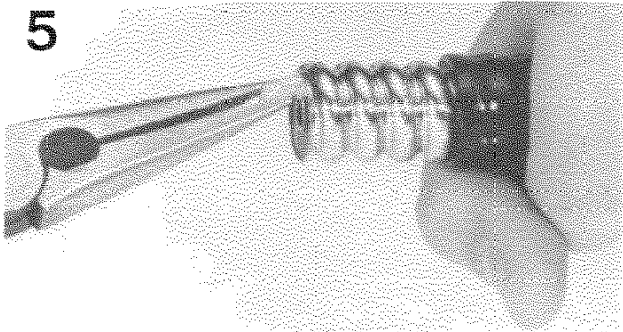
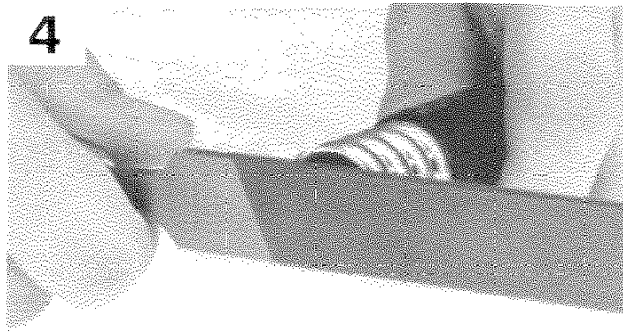

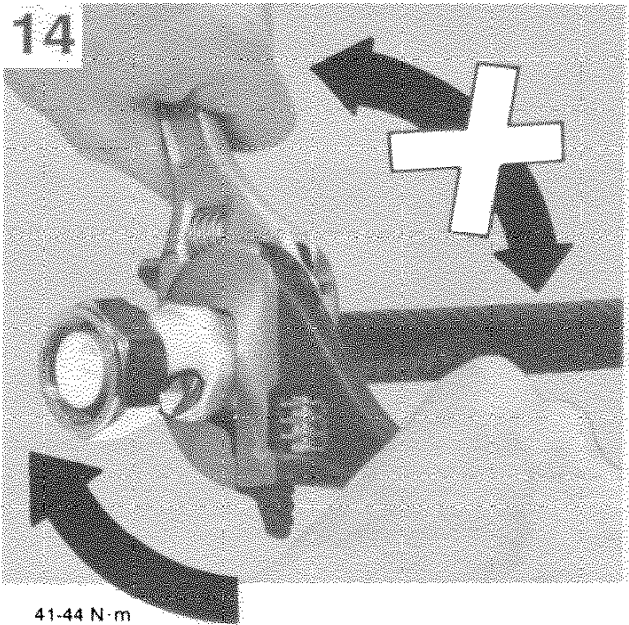
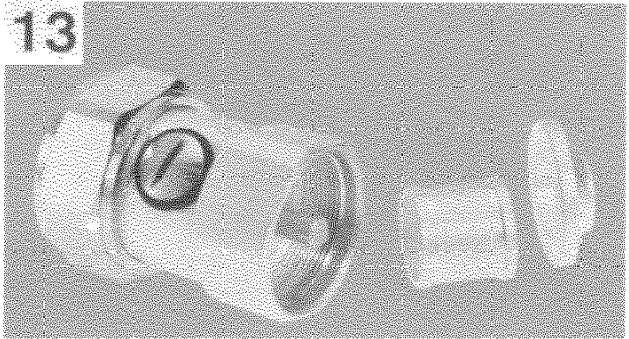
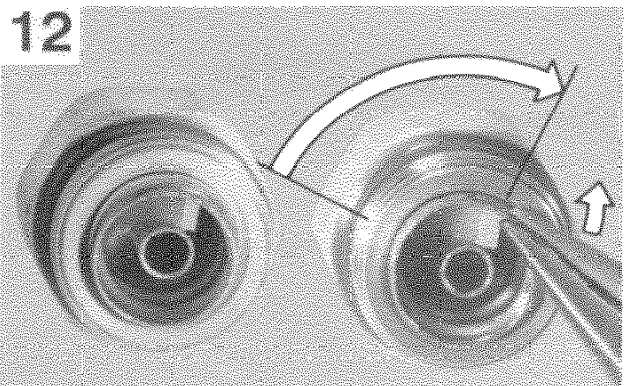
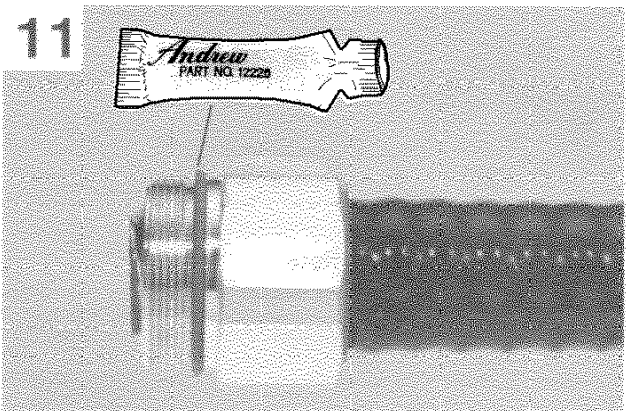
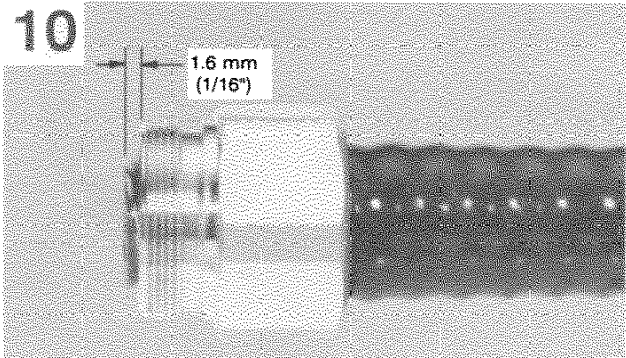
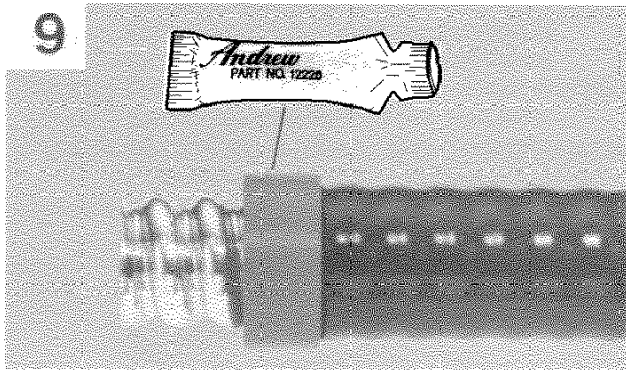

Notice

The installation, maintenance, or removal of antenna systems requires qualified, experienced personnel. Andrew installation instructions have been written for such personnel. Antenna systems should be inspected once a year by qualified personnel to verify proper installation, maintenance, and condition of equipment.

Andrew disclaims any liability or responsibility for the results of improper or unsafe installation practices.

Advertencia

Se requiere que la instalación, el mantenimiento o el retiro de los sistemas de antenas sea efectuado por personal calificado y con experiencia. Las instrucciones de instalación de Andrew se han escrito pensando en esta clase de personal. Se deben inspeccionar los sistemas de antenas una vez al año utilizando personal calificado a fin de verificar si la instalación, el mantenimiento y la condición del equipo son adecuados.

Andrew no asume ninguna responsabilidad ni obligación resultante de las prácticas de instalación incorrectas o inseguras.

Note

L'installation, la maintenance et la dépose des systèmes d'antennes doivent être effectuées par des techniciens qualifiés. Les instructions de montage Andrew ont été prévues pour un tel personnel. Les systèmes d'antennes doivent être inspectés tous les ans par des techniciens qualifiés afin de vérifier l'installation, la maintenance et l'état des équipements.

Andrew décline toute responsabilité dans le cas de non respect de ces instructions.

Anmerkung

Die Installation, Wartung oder Abnahme eines Antennensystems erfordert qualifiziertes und geschultes Personal, für das auch die Andrew Montageanweisungen geschrieben worden sind. Antennensysteme sollten jährlich von qualifiziertem Personal überprüft werden, um die einwandfreie Montage, Wartung und den Zustand der Systemkomponenten sicherzustellen.

Andrew lehnt jede Haftung oder Verantwortung für Schaden ab, die aufgrund unsachgemäßer Installation resultieren.



Andrew Corporation
10500 West 153rd Street
Orland Park, IL U.S.A. 60462

Technical Services, 24 hours: 708/349-5900
Telephone: 708/349-3300 Telcx: 25-3897
FAX: 708/349-5943

Printed in U.S.A. 1/93
Copyright © 1993 by Andrew Corporation