

ITEM	PART NO.	DESCRIPTION	QTY.	WEIGHT	NOTE NO.
1	BX91	BOX, KRAFT, 36" X 4" X 4"	1	0.43 LBS	
2	MT50436	1-5/8" SQ. SUPPORT RAIL 36" LONG	2	5.62 LBS	
3	MTC333907	WALL MOUNT BRACKET	2	1.82 LBS	
4	RRWM3HB	HARDWARE BAG FOR RR-MW3	1	7.17 LBS	
5	DOCUMENT RECORD	INSERT DRAWING RR-MW3 INTO BOX	1	-	2

REVISIONS				
REV.	ECN	DESCRIPTION	BY	DATE
A		INITIAL RELEASE	MSM	03/08/16
B	8000012889	ADD PACKING SHEET	MSM	03/09/16

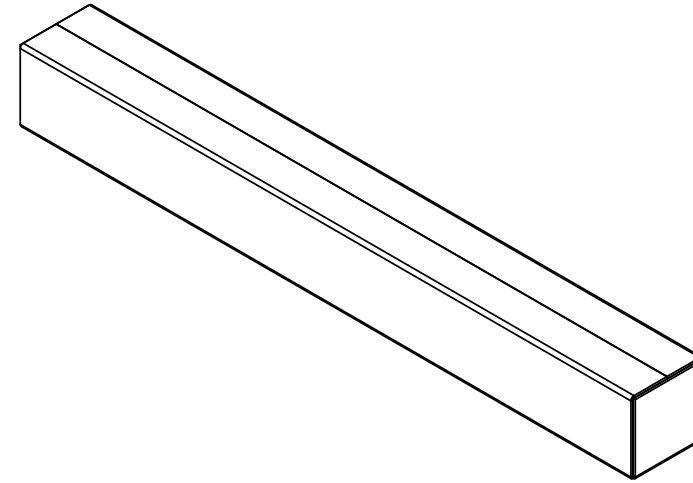



NOTES:

1. ALL METRIC DIMENSIONS ARE IN BRACKETS.
2. PLACE DRAWING INTO BOX.

These drawings and specifications are the proprietary property of CommScope Inc. and may be used only for the specific purpose authorized in writing by CommScope Inc. ALL DIMENSIONS ARE IN INCHES U.O.S. TOLERANCES UNLESS OTHERWISE SPECIFIED: .X = ± .12 ANGLES ±2° .XX = ± .06 FRACTIONS ±1/32 .XXX= ± .03 REMOVE BURRS AND BREAK EDGES .005 DO NOT SCALE THIS PRINT	DRAWN BY: RJC	SHEET: 1 of 2	PART NUMBER: RR-WM3
	CHECKED BY: TP	SCALE: NTS	DESCRIPTION: RRU Seismic Wall Mount
	DATE: 12/19/14	MATERIAL: A36	DRAWING TYPE: ASSEMBLY DRAWING
	REVISION: B	FINISH: GALV A123	 Hickory, NC 28602 U.S.A.
	WEIGHT: 22.49 LBS		

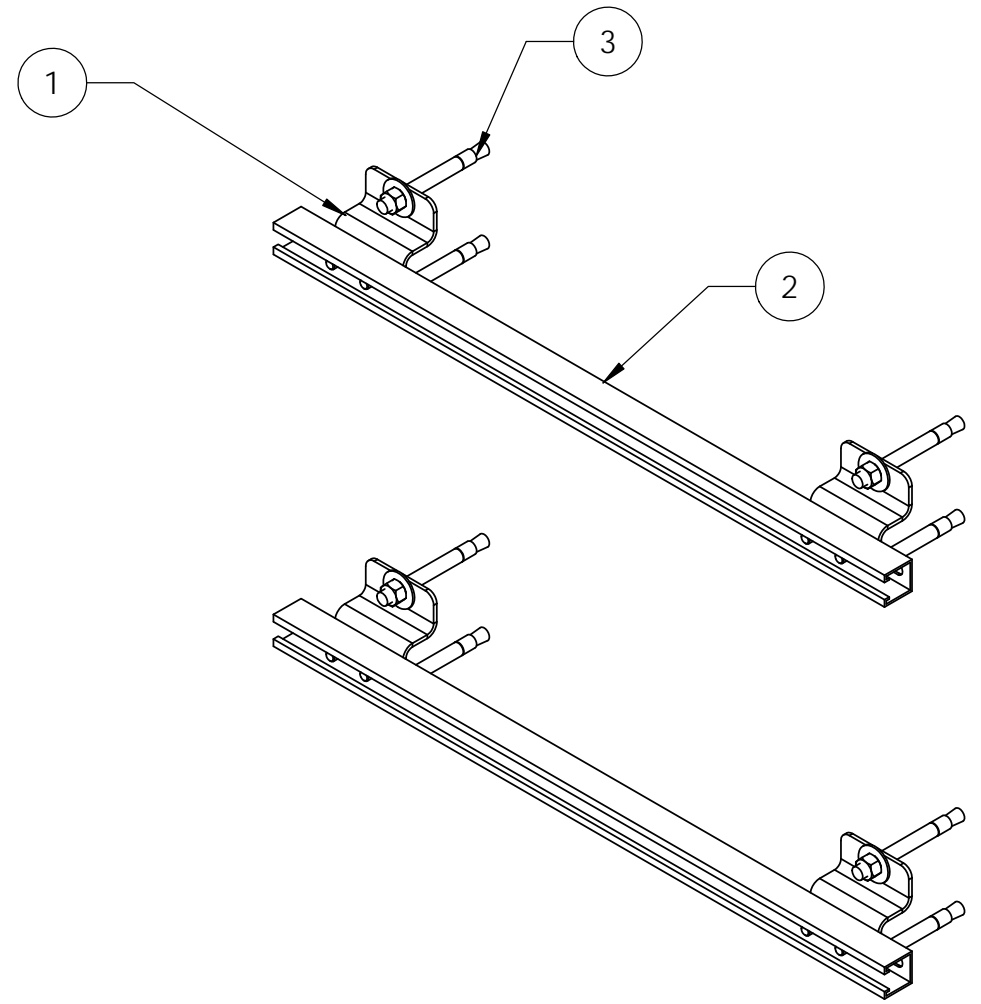
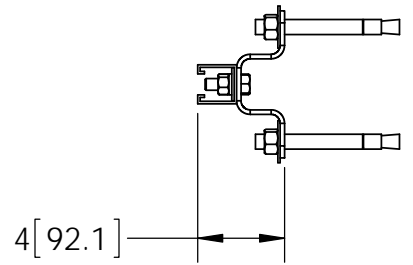
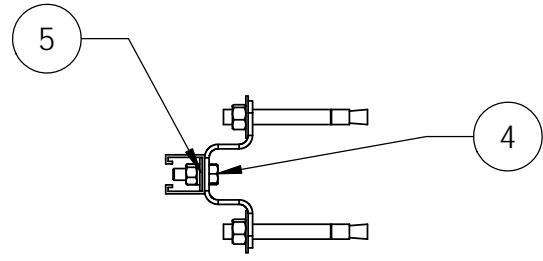
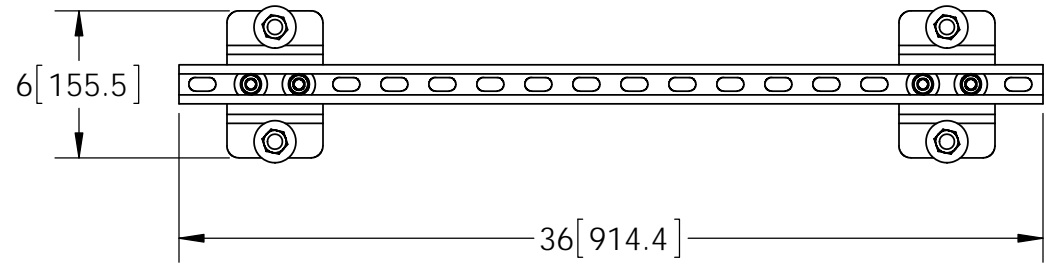
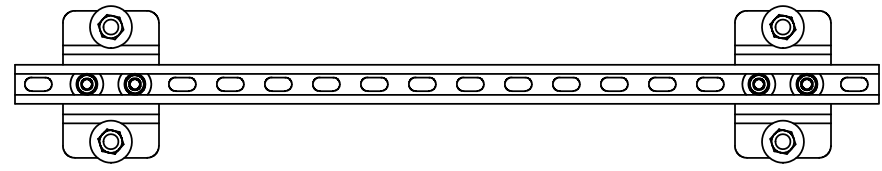
ITEM	PART NO.	DESCRIPTION	QTY.	WEIGHT	NOTE NO.
1	MTC333907	WALL MOUNT BRACKET	4	1.82 LBS	
2	MT50436	1-5/8" SQ. SUPPORT RAIL 36" LONG	2	5.62 LBS	
3	MT-280	5/8" ANCHOR BOLT	8	0.64 LBS	
4	GB-04145	1/2" X 1-1/2" GALV BOLT KIT	8	0.13 LBS	
5	GWF-04	1/2" GALV FLAT WASHER	8	0.03 LBS	



<p>These drawings and specifications are the proprietary property of CommScope Inc. and may be used only for the specific purpose authorized in writing by CommScope Inc.</p> <p>ALL DIMENSIONS ARE IN INCHES U.O.S. TOLERANCES UNLESS OTHERWISE SPECIFIED: .X = ± .12 ANGLES ±2° .XX = ± .06 FRACTIONS ±1/32 .XXX = ± .03</p> <p>REMOVE BURRS AND BREAK EDGES .005</p> <p>DO NOT SCALE THIS PRINT</p>	DRAWN BY: RJC	SHEET: 2 of 2	PART NUMBER: RR-WM3
	CHECKED BY: TP	SCALE: NTS	DESCRIPTION: RRU Seismic Wall Mount
	DATE: 12/19/14	MATERIAL: A36	DRAWING TYPE: ASSEMBLY DRAWING
	REVISION: B	FINISH: GALV A123	 Hickory, NC 28602 U.S.A.
	WEIGHT: 25.46 LBS		