

NDX-10BTMOU-A0450F



DLX® Fiber Indexing Terminal, 1x8 Splitter, 8 Forward Ports, 1 Reverse Port, Dielectric Flat Loose Tube Cable, 450 Feet

- Fiber Indexing terminals are access terminals using hardened connectivity technology that withstand the rugged outside plant environment
- Fiber Indexing terminals eliminate splicing and use 12-strand fiber cable in a daisy-chain topology, reducing the total required cable length by up to 70%
- Hardened adapters are factory-terminated and environmentally sealed to ensure rapid plug-and-play drop cable installations

Product Classification

| | |
|------------------------------|--|
| Regional Availability | North America |
| Product Type | Access terminal, indexed with splitter |
| Product Brand | DLX® |
| Product Series | NDX |

General Specifications

| | |
|-------------------------------|--|
| Cable Type | Dielectric - Flat - Loose Tube |
| Cable, quantity | 1 |
| Distribution Type | 1 x 8 splitter |
| Enclosure Color | Black |
| Forward Port Type | Hardened mini-size (DLX) adapter |
| Forward Port, quantity | 8 |
| Mounting | Handhole Pedestal Pole |
| Port Type | Hardened multi-fiber (HMFOC) jack, male/pinned |
| Port, quantity | 1 |
| Reverse Port Type | Hardened mini-size DLX |
| Reverse Port, quantity | 1 |
| Splitter, quantity | 1 |
| Stub Type | Hardened multi-fiber (HMFOC) plug |

Dimensions

| | |
|---------------|----------------------|
| Height | 297.8 mm 11.724 in |
| Width | 130.3 mm 5.13 in |

NDX-10BTMOU-A0450F

| | |
|-----------------------------|-------------------------------|
| Depth | 90.4 mm 3.559 in |
| Cable Length, stub | 450 ft (137 m) |
| Cable Outer Diameter | 4.5 x 8.1 mm (0.18 x 0.32 in) |

Dimension Drawing

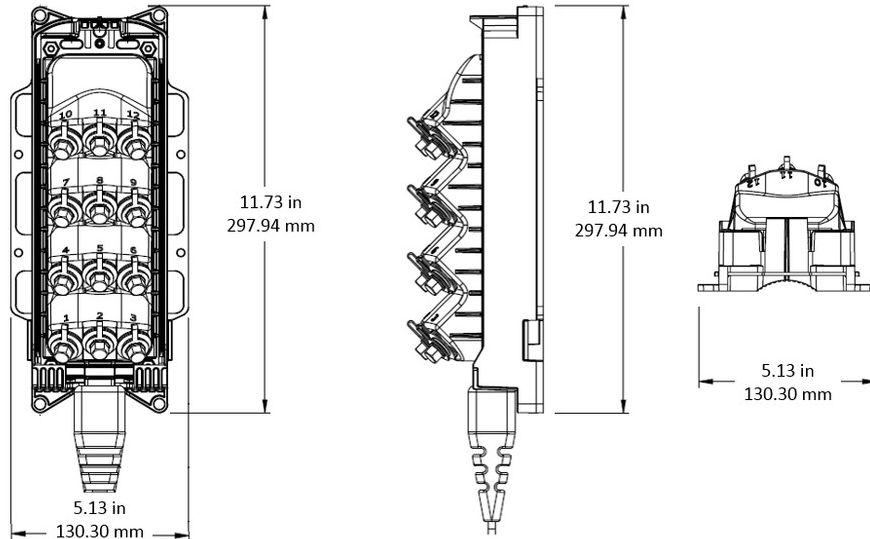

Ordering Tree

NDX-10BTMOU-A0450F



Material Specifications

Enclosure Material Type

Gasketed hardened plastic

Optical Specifications

Fiber Type

G.652.D

Operating Wavelength Range

1260 – 1635 nm

Attenuation Cable Coefficient, maximum

0.30 dB/km @ 1550 nm | 0.40 dB/km @ 1310 nm

Attenuation Splitter, maximum

10.4 dB

Attenuation Terminal Connectors, maximum

0.45 dB

Directivity, minimum

60 dB

Uniformity, maximum

1 dB

Insertion Loss, Splitter, typical

10 dB

Insertion Loss, Stub Connector, maximum

0.45 dB

Insertion Loss, Stub Connector, typical

0.16 dB

Insertion Loss, Terminal Connector, typical

0.16 dB

Return Loss, Connector, minimum

65 dB

NDX-10BTMOU-A0450F

Return Loss, Single Ports, minimum 55 dB

Environmental Specifications

Operating Temperature -40 °C to +70 °C (-40 °F to +158 °F)
Relative Humidity 5%–100%, condensing
Environmental Space Above ground | Below ground | Buried
Flammability Rating UL 94 V-0
Qualification Standards IEC 60529, IP68 + 2 m waterhead | NEMA, Type 6 + 10 ft waterhead | Telcordia GR-3120-CORE | Telcordia GR-326-CORE | Telcordia GR-771-CORE
UV Resistance UV stabilized

Packaging and Weights

Included Enclosure (1) | Optical splitter (1) | Universal mounting bracket (1)
Packaging quantity 1
Packaging Type Box | Carton
Weight, without cable 1 kg | 2.205 lb

Regulatory Compliance/Certifications

| Agency | Classification |
|---------------|--|
| CHINA-ROHS | Below maximum concentration value |
| ISO 9001:2015 | Designed, manufactured and/or distributed under this quality management system |
| REACH-SVHC | Compliant as per SVHC revision on www.commscope.com/ProductCompliance |
| ROHS | Compliant |
| UK-ROHS | Compliant |



Included Products

MST-UMB-MINI – DLX® Mini-MST, Fiber Optic Universal Mounting Bracket