

# HST-B2AAA0900NN000



## HST, NOVUX™ Prodigy™ Hardened Standard Terminal, 2-port Planar 1:2 Splitter, Dielectric flat loose tube cable, 900 ft/274 m

- NOVUX™ Prodigy™ Hardened Multi-port Terminals incorporate Hardened connector technology that is designed to withstand the rugged outside plant environment
- Hardened connectors are factory-integrated and environmentally sealed for use in optical drop cable deployments
- Plug and play adapter ports ensure rapid cable installment in the outside plant access section of the network
- NOVUX™ Prodigy™ HST terminals are available with 2 to 12 ports and can be utilized in Single Fiber Point-to-Point (P2P) solutions
- Available with flat dielectric, flat toneable/locatable dielectric, armored or 5mm round cable
- NOVUX™ Prodigy™ smaller terminal size for aesthetics and allowing installation in constrained spaces
- NOVUX™ Prodigy™ terminals are available in Black (RAL# 9005) or Gray (RAL# 7035)
- CommScope Product ID plate with QR code link to product documents and C-Track

## Product Classification

|                               |   |
|-------------------------------|---|
| <b>Regional Availability</b>  | Asia   EMEA   Latin America   North America |
| <b>Product Type</b>           | Access terminal, with splitter/tap          |
| <b>Product Brand</b>          | NOVUX™                                      |
| <b>Product Series</b>         | HST   |
| <b>Minimum Order Quantity</b> | 1   |

## General Specifications

|                            |                                     |
|----------------------------|-------------------------------------|
| <b>Cable Type</b>          | Dielectric - Flat - Loose Tube      |
| <b>Cable, quantity</b>     | 1                                   |
| <b>Distribution Type</b>   | 1 x 2 splitter                      |
| <b>Drop Port Type</b>      | Hardened Prodigy SC/APC             |
| <b>Drop Port, quantity</b> | 2                                   |
| <b>Enclosure Color</b>     | Black (RAL 9005)                    |
| <b>Mounting</b>            | Handhole   Pedestal   Pole   Strand |
| <b>Port Type</b>           | Hardened Prodigy SC/APC             |
| <b>Port, quantity</b>      | 2                                   |
| <b>Splitter, quantity</b>  | 1                                   |
| <b>Stub Type</b>           | Stub tail                           |

# HST-B2AAA0900NN000

## Dimensions

|                             |                               |
|-----------------------------|-------------------------------|
| <b>Height</b>               | 80 mm   3.15 in               |
| <b>Width</b>                | 79 mm   3.11 in               |
| <b>Length</b>               | 161 mm   6.339 in             |
| <b>Cable Length, stub</b>   | 900 ft (274 m)                |
| <b>Cable Outer Diameter</b> | 4.3 x 8.0 mm (0.17 x 0.31 in) |

## Dimension Drawing

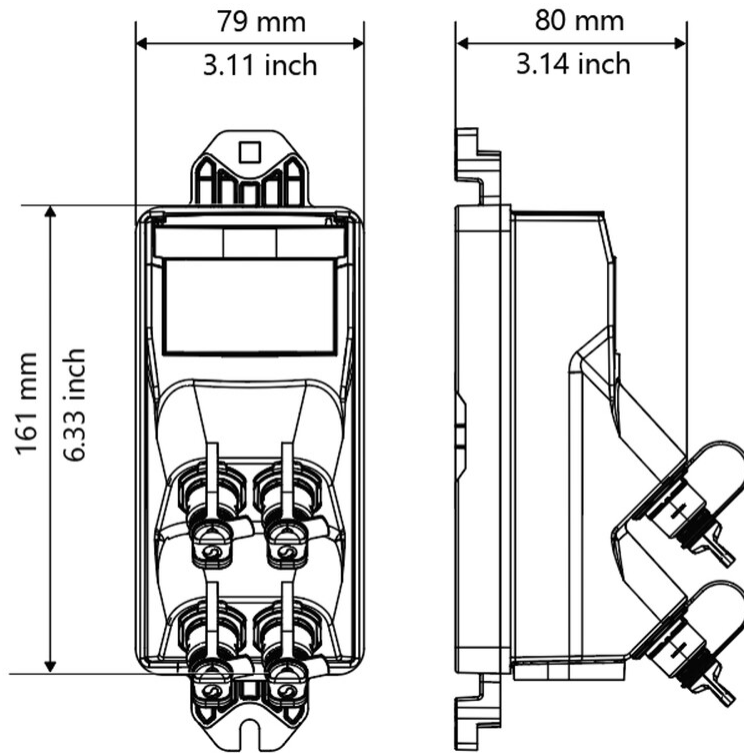

## Port Configuration

| NOVUX HT   | TECHNOLOGIES AVAILABLE         | SMALL                          | MEDIUM                         | LARGE                          |   |
|------------|--------------------------------|--------------------------------|--------------------------------|--------------------------------|---|
| HST Series | Single-fiber: P2P/no splitters | 2 ports                        | 6 ports                        | 12 ports                       |   |
|            |                                | 4 ports                        | 8 ports                        |                                |   |
|            | Single-fiber: P2P w/splitters  | 2 ports, 1x1:2                 | 8 ports, 2x1:4                 | 12 ports, 3x1:4                |   |
|            |                                | 4 ports, 1x1:4                 | 8 ports, 1x1:8                 |                                |   |
|            | Hybrid for multi-use           |                                |                                | 7 ports, 1x1:4 splitter, 3 P2P | 12 ports, 1x1:8 splitter, 4 P2P             |
|            |                                | 4 ports, 1x1:2 splitter, 2 P2P | 8 ports, 1x1:4 splitter, 4 P2P |                                | 11 ports, 2x1:4 splitter, 2 P2P, 1 HMFOC 4f |

## Ordering Tree

# HST-B2AAA0900NN000



## Material Specifications

**Enclosure Material Type** Hardened plastic

## Optical Specifications

**Fiber Type** G.657.A1/A2

**Operating Wavelength Range** 1260 – 1635 nm

**Attenuation Single Ports, maximum** 4.1 dB

**Attenuation Cable Coefficient, maximum** 0.30 dB/km @ 1550 nm | 0.40 dB/km @ 1310 nm

**Attenuation Splitter, maximum** 3.7 dB

**Attenuation Terminal Connectors, maximum** 0.4 dB

**Return Loss, Single Ports, minimum** 55 dB

## Environmental Specifications

**Operating Temperature** -40 °C to +65 °C (-40 °F to +149 °F)

**Relative Humidity** 5%–100%, condensing

# HST-B2AAA0900NN000

---

|                                |   |
|--------------------------------|---|
| <b>Environmental Space</b>     | Above ground   Below ground   |
| <b>Qualification Standards</b> | IEC 61753-1, category G   IEC 61753-111-08 (this represents an IEC 60529 IP68 intrusion protection level) |
| <b>UV Resistance</b>           | UV stabilized   |
| <b>Packaging and Weights</b>   |   |
| <b>Packaging quantity</b>      | 1   |
| <b>Packaging Type</b>          | Box   Universal spool, cardboard: terminal is on top of the spool, stub deploys first                     |

## Regulatory Compliance/Certifications

| <b>Agency</b> | <b>Classification</b>  |
|---------------|--|
| CHINA-ROHS    | Below maximum concentration value  |
| ISO 9001:2015 | Designed, manufactured and/or distributed under this quality management system   |
| REACH-SVHC    | Compliant as per SVHC revision on <a href="http://www.commscope.com/ProductCompliance">www.commscope.com/ProductCompliance</a> |
| ROHS          | Compliant  |
| UK-ROHS       | Compliant  |

