

HXT-B4AMA0500FU000



NOVUX™ Prodigy™ Hardened Indexing Terminal, 12 Fiber Multi-use 2F, two 1F Prodigy Adapter ports, 1 HMFOC Reverse port, Dielectric flat loose tube, 500 ft/152 m HMFOC Plug (female/no pin) tail, with mounting bracket

- NOVUX™ Hardened Multi-fiber Terminals incorporate hardened connector technology that is designed to withstand the rugged outside plant environment
- Hardened connectors are factory-integrated and environmentally sealed for use in optical drop cable deployments
- Plug-and-play adapter ports ensure rapid cable installment in the outside plant access section of the network
- NOVUX™ Prodigy™ HXT fiber indexing terminals are available with 1:4 or 1:8 splitter and optional multi-use ports, Index Only and Index Branching 2 to 6 fiber solutions
- Available stubless or with flat dielectric and flat toneable/locatable dielectric cable with HMFOC Plug (female/no pin)
- NOVUX™ Prodigy™ smaller terminal size for aesthetics and allowing installation in constrained spaces
- NOVUX™ Prodigy™ terminals are available in Black (RAL# 9005) or Gray (RAL# 7035)
- CommScope Product ID plate with QR code link to product documents and C-Track

Product Classification

Regional Availability	Asia EMEA Latin America North America
Product Type	Access terminal, without splitter/tap
Product Brand	NOVUX™
Product Series	HXT
Minimum Order Quantity	1

General Specifications

Cable Type	Dielectric - Flat - Loose Tube
Cable, quantity	1
Distribution Type	12F multi-use 2F
Drop Port Type	Hardened Prodigy SC/APC
Drop Port, quantity	2
Enclosure Color	Black (RAL 9005)
Forward Port Type	Hardened multi-fiber (HMFOC) jack, male/pinned
Forward Port, quantity	1
Mounting	Handhole Pedestal Pole Strand

HXT-B4AMA0500FU000

Port Type	Hardened Prodigy SC/APC
Port, quantity	4
Reverse Port Type	Hardened multi-fiber (HMFOC) jack, male/pinned
Reverse Port, quantity	1
Stub Type	Hardened multi-fiber (HMFOC) plug, female/no pin

Dimensions

Height	80 mm 3.14 in
Width	79 mm 3.11 in
Length	161 mm 6.33 in
Cable Length, stub	500 ft (152 m)
Cable Outer Diameter	4.3 x 8.0 mm (0.17 x 0.31 in) in

Dimension Drawing

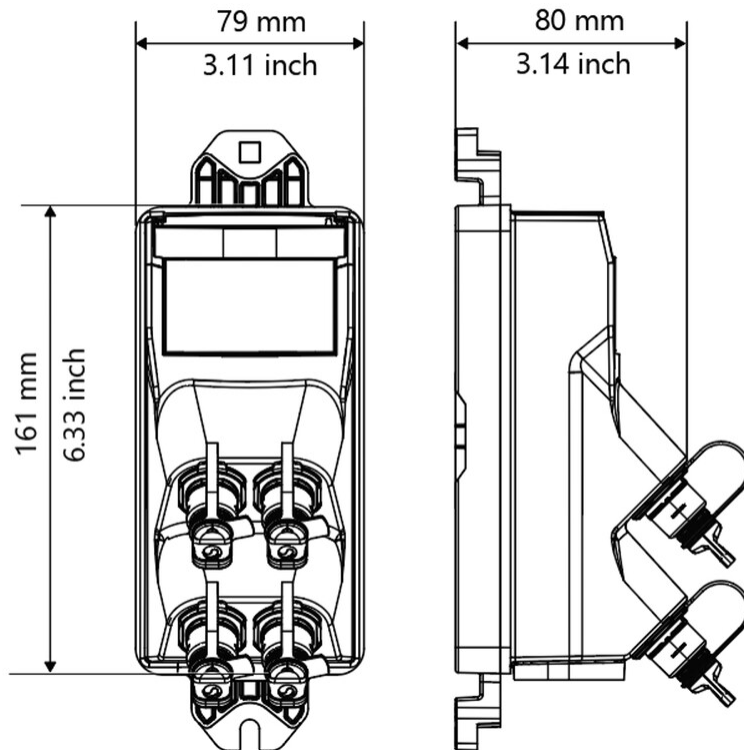

Port Configuration

HXT-B4AMA0500FU000

NOVUX HT	TECHNOLOGIES AVAILABLE	SMALL	MEDIUM	LARGE
HXT Series	Fiber indexing	12 fiber index only, 1f	12 fiber 1:4	12 fiber 1:8
		12 fiber index only, 2f	12f multi-use 2f + 1:4	12 fiber multi-use, 3f +1:4
		12 fiber index only, 3f	24f multi-use 2f	12 fiber multi-use, 4f +1:4
		12 fiber index only, 4f	24f multi-use 3f	12 fiber multi-use, 2f +1:8
		12 fiber multi-use, 2f	24f multi-use 4f	
		12 fiber branching, 2 to 6f per port		

Ordering Tree



Material Specifications

Enclosure Material Type Hardened plastic

Optical Specifications

Fiber Type G.657.A1/A2

Operating Wavelength Range 1260 – 1635 nm

Attenuation Single Ports, maximum 0.4 dB

Attenuation Cable Coefficient, maximum 0.30 dB/km @ 1550 nm | 0.40 dB/km @ 1310 nm

Insertion Loss, Stub Connector, maximum 0.65 dB

Return Loss, Connector, maximum 65 dB

HXT-B4AMA0500FU000

Environmental Specifications

Operating Temperature	-40 °C to +65 °C (-40 °F to +149 °F)
Relative Humidity	5%–100%, condensing
Environmental Space	Above ground Below ground
Qualification Standards	IEC 60529, IP68 + 2 m waterhead IEC 61753-1, category G
UV Resistance	UV stabilized

Packaging and Weights

Included	Universal mounting bracket
Packaging quantity	1
Packaging Type	Box Universal spool, cardboard: terminal is on top of the spool, stub deploys first

Regulatory Compliance/Certifications

Agency	Classification
CHINA-ROHS	Below maximum concentration value
ISO 9001:2015	Designed, manufactured and/or distributed under this quality management system
REACH-SVHC	Compliant as per SVHC revision on www.commscope.com/ProductCompliance
ROHS	Compliant
UK-ROHS	Compliant

