

VHLP2-X80X23-DET/B



0.6 m | 2 ft ValuLine® High Performance Low Profile Antenna, dual band, dual polarised 71.000 – 86.000 GHz and dual polarised 21.200 – 23.600 GHz, OEM custom flange

Product Classification

Product Type	Microwave antenna
Product Brand	ValuLine®

General Specifications

Antenna Type	VHLP - ValuLine® High Performance Low Profile Antenna, dual band
Polarization	Dual 80 GHz, Dual 23 GHz
Antenna Input	OEM specific
Antenna Color	White
Reflector Construction	One-piece reflector
Radome Color	Gray
Radome Material	Composite Broadband
Flash Included	No
Side Struts, Included	0
Side Struts, Optional	0

Dimensions

Diameter, nominal	0.6 m 2 ft
--------------------------	--------------

Electrical Specifications

Operating Frequency Band	71.000 – 86.000 GHz
Gain, Low Band	48.5 dBi
Gain, Mid Band	49.5 dBi
Gain, Top Band	50 dBi
Boresite Cross Polarization Discrimination (XPD)	30 dB
Front-to-Back Ratio	68 dB
Beamwidth, Horizontal	0.5 °
Beamwidth, Vertical	0.5 °

VHLP2-X80X23-DET/B

Return Loss	15 dB
VSWR	1.43
Radiation Pattern Envelope Reference (RPE)	7442B
Electrical Compliance	Canada SRSP 371.0 Part A ETSI 302 217 Class 3 FCC Cat A

Electrical Specifications, Band 2

Operating Frequency Band	21.200 – 23.600 GHz
Gain, Low Band	39.3 dBi
Gain, Mid Band	39.4 dBi
Gain, Top Band	39.5 dBi
Beamwidth, Horizontal	1.5 °
Beamwidth, Vertical	1.5 °
Boresite Cross Polarization Discrimination (XPD)	30 dB
Electrical Compliance	Canada SRSP 321.8 B ETSI 302 217 Class 3 FCC Cat A
Front-to-Back Ratio	66 dB
Radiation Pattern Envelope Reference (RPE)	7441B
Return Loss	15 dB
VSWR	1.43

Mechanical Specifications

Compatible Mounting Pipe Diameter	50 mm–115 mm 2.0 in–4.5 in
Fine Azimuth Adjustment Range	±8°
Fine Elevation Adjustment Range	±15°
Wind Speed at 23 GHz, operational	180 km/h 111.847 mph
Wind Speed at 80 GHz, operational	144 km/h 89.477 mph
Wind Speed, survival	250 km/h 155.343 mph

Antenna Dimensions and Mounting Information

VHLP2-X80X23-DET/B

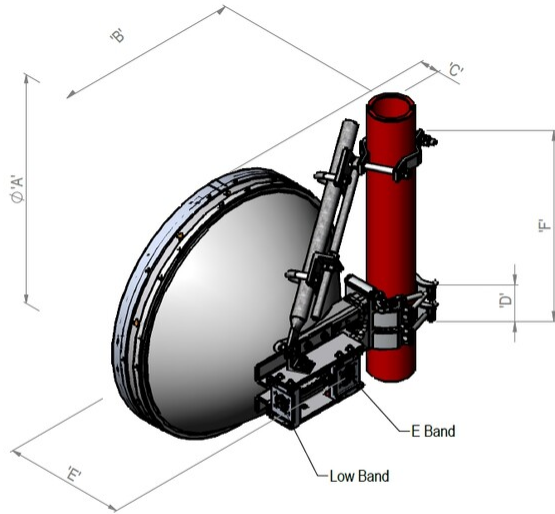

Dimensions in mm (Inches)						
Antenna Size, ft (m)	A	B	C	D	E	F
2 (0.6)	660 (25.9)	309 (12.2)	283 (11.1)	106 (4.2)	462 (18.2)	505 (19.8)

Wind Forces at Wind Velocity Survival Rating

Axial Force (FA)	1693 N 380.602 lbf
Side Force (FS)	814 N 182.995 lbf
Twisting Moment (MT)	756 N-m 6,691.164 in lb
Zcg without Ice	9 mm 0.354 in

VHLP2-X80X23-DET/B

Wind Forces at Wind Velocity Survival Rating Image



Packaging and Weights

Height, packed	600 mm 23.622 in
Width, packed	740 mm 29.134 in
Length, packed	740 mm 29.134 in
Packaging Type	Standard pack
Volume	0.3 m ³ 10.594 ft ³
Weight, gross	23 kg 50.706 lb
Weight, net	17 kg 37.479 lb

* Footnotes

VHLP2-X80X23-DET/B

Operating Frequency Band	Bands correspond with CCIR recommendations or common allocations used throughout the world. Other ranges can be accommodated on special order.
Gain, Mid Band	For a given frequency band, gain is primarily a function of antenna size. The gain of Andrew antennas is determined by either gain by comparison or by computer integration of the measured antenna patterns.
Boresite Cross Polarization Discrimination (XPD)	The difference between the peak of the co-polarized main beam and the maximum cross-polarized signal over an angle twice the 3 dB beamwidth of the co-polarized main beam.
Front-to-Back Ratio	Denotes highest radiation relative to the main beam, at $180^\circ \pm 40^\circ$, across the band. Production antennas do not exceed rated values by more than 2 dB unless stated otherwise.
Return Loss	The figure that indicates the proportion of radio waves incident upon the antenna that are rejected as a ratio of those that are accepted.
VSWR	Maximum; is the guaranteed Peak Voltage-Standing-Wave-Ratio within the operating band.
Radiation Pattern Envelope Reference (RPE)	Radiation patterns define an antenna's ability to discriminate against unwanted signals. Under still dry conditions, production antennas will not have any peak exceeding the current RPE by more than 3dB, maintaining an angular accuracy of $\pm 1^\circ$ throughout
Radiation Pattern Envelope Reference (RPE)	Radiation patterns define an antenna's ability to discriminate against unwanted signals. Under still dry conditions, production antennas will not have any peak exceeding the current RPE by more than 3dB, maintaining an angular accuracy of $\pm 1^\circ$ throughout
Wind Speed, survival	The maximum wind speed the antenna, including mounts and radomes, where applicable, will withstand without permanent deformation. Realignment may be required. This wind speed is applicable to antenna with the specified amount of radial ice.
Axial Force (FA)	Maximum forces exerted on a supporting structure as a result of wind from the most critical direction for this parameter. The individual maximums specified may not occur simultaneously. All forces are referenced to the mounting pipe.
Side Force (FS)	Maximum side force exerted on the mounting pipe as a result of wind from the most critical direction for this parameter. The individual maximums specified may not occur simultaneously. All forces are referenced to the mounting pipe.
Twisting Moment (MT)	Maximum forces exerted on a supporting structure as a result of wind from the most critical direction for this parameter. The individual maximums specified may not occur simultaneously. All forces are referenced to the mounting pipe.

VHLP2-X80X23-DET/B

Packaging Type

Andrew standard packing is suitable for export. Antennas are shipped as standard in totally recyclable cardboard or wire-bound crates (dependent on product). For your convenience, Andrew offers heavy duty export packing options.