

NOVUX™ Fiber Optic System CC 200 Drop Patch Application

About this manual

This manual describes the installation steps of the drop patch application of the Compact Closure 200 series. Installation steps in this document are limited to: splice input connectors to feeder fiber, splitter application in the pocket zone and install connectorized drop cable (SC, LC, SC Xpres and duplex LC Xpres). Installation steps of the feeder cables are explained in manual TC-1547-IP: CC 200 Basic Instructions. Installation steps of the branch applications are explained in manual TC-1547-IP-BR: CC 200 Branch Application. The document starts with providing an overview of the tools required to perform the installation. Also warnings and cautions are indicated, which should be observed before starting the product installation. Images in this manual are for reference only and are subject to change.

General product information

	Quantity drops	Installation method drops
SC/APC or SC/UPC	up to 12	Pre-connectorized, Xpres drop
LC/APC or LC/UPC	up to 24	Pre-connectorized, dual Xpres drop

Overview organizer

Different patch configurations are available: SC, LC, SC Xpres, duplex LC Xpres,..
 First figure below shows SC Xpres configuration, second figure shows the LC configuration.

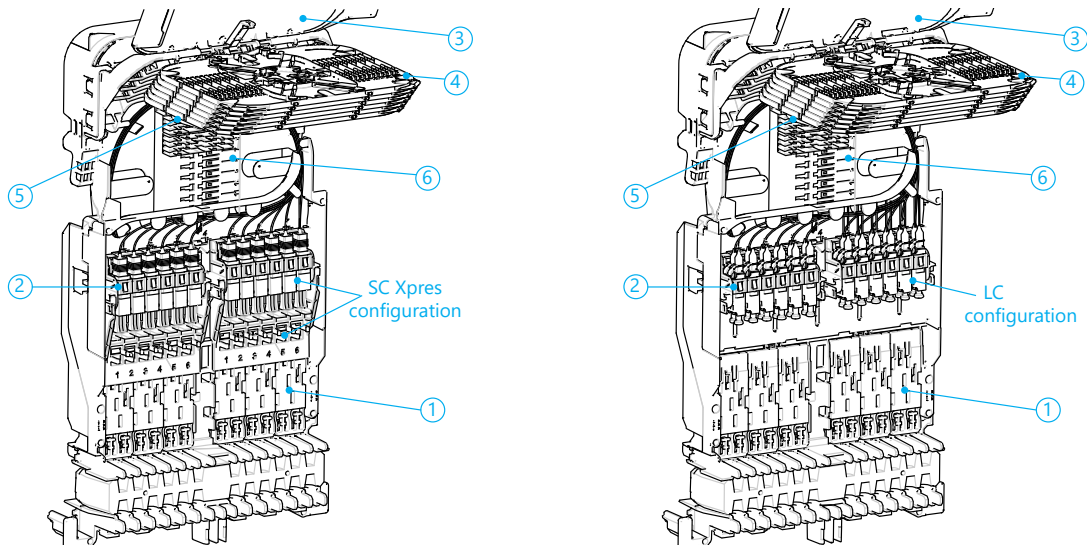

- 1 Drop cable positions
- 2 Adapters with input connectors factory installed (SC or LC)
- 3 Demarcation cover
- 4 Splice trays
- 5 Storage trays
- 6 Pocket with input 900µm (12 or 24) temporarily stored

Contents

1 Tools.....	3	4 Install drop cable.....	8
2 Warnings and Cautions.....	3	4.1 Install SC-connectorized cable.....	8
3 Splice feeder to input connector.....	4	4.2 Install SC Xpres drop.....	9
3.1 Pocket zone.....	4	4.3 Install SC-connectorized cable in a fixed 16 patch panel.....	10
3.2 Splice feeder direct to input connectors.....	4	4.4 Install LC-connectorized cable.....	11
3.3 Splice feeder to a factory installed splitter.....	6	4.5 Install duplex LC Xpres drop.....	12
3.4 Splice feeder and input connectors to a field installable splitter.....	7	5 Disclaimer.....	13
		6 Contact information.....	13

1 Tools

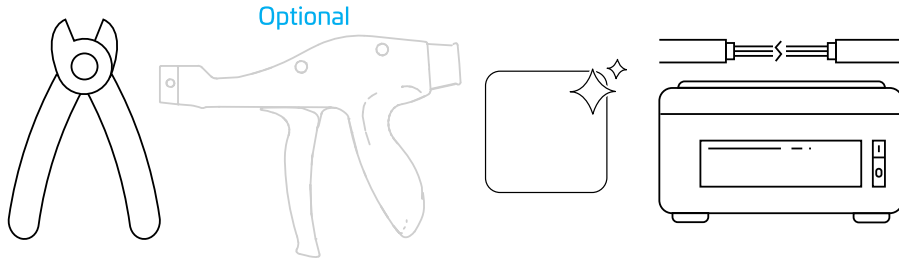

- Small side cutter or Cable Tie Gun (to cut excess cable tie)
- Fiber splice equipment and fiber cleaning tools

2 Warnings and Cautions

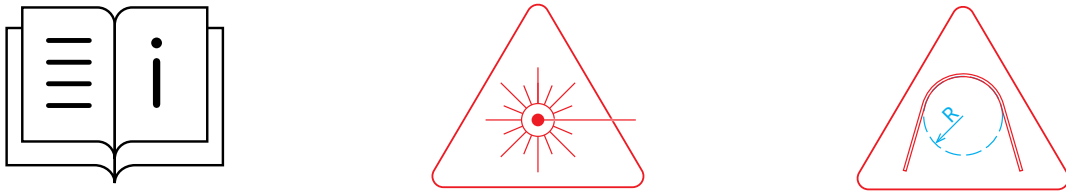

- Follow the installation instruction steps to ensure the performance of the closure. It is necessary to take precautions and keep the working space clean to protect the closure sealing materials and splices.
- Exposure to laser radiation can seriously damage the retina of the eye. Do not look into the ends of any optical fiber. Do not assume the laser power is turned off or that the fiber is disconnected at the other end. Looking into the ends of any optical fiber is entirely at your own risk. A protective cap or hood **MUST** be immediately placed over any radiating adapter or optical fiber connector to avoid the potential of dangerous amounts of radiation exposure. This practice also prevents dirt particles from entering the connector and adapter.
- Fiber optic cables may be damaged if bent or curved to a radius that is less than the recommended minimum bend radius. Always observe the recommended bend radius limit when installing fiber optic cables, subunits and patch cords.

3 Splice feeder to input connector

Prepare and install the feeder cable as explained in the CC 150 base instructions TC-1514-IP.

3.1 Pocket zone

Under the trays an area is available for splicing and passive optical components (POC) storage. This area is the pocket.

 **Note:** Fibers stored in this area are non transient free.

	Quantity	specifications
Splice protector holders	up to 24	Splice protectors length is up to 45 mm / 1.77 Inches
Splitters	up to 3 splitters	Factory installed or Field installable

 **Note:** The configuration of the pocket is very flexible. The illustrations in the next sections are for reference only and can differ from ordered configuration.

3.2 Splice feeder direct to input connectors

 **Note:** Figures below show 12 SC input connectors, same procedure is applicable for the 24 input connectors on the LC configurations.

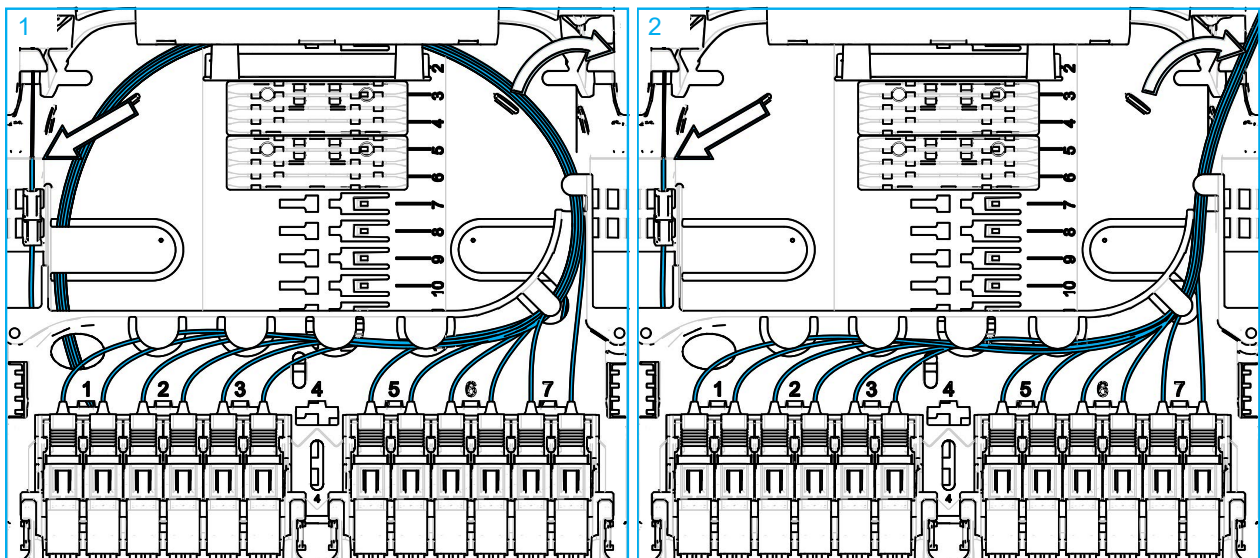

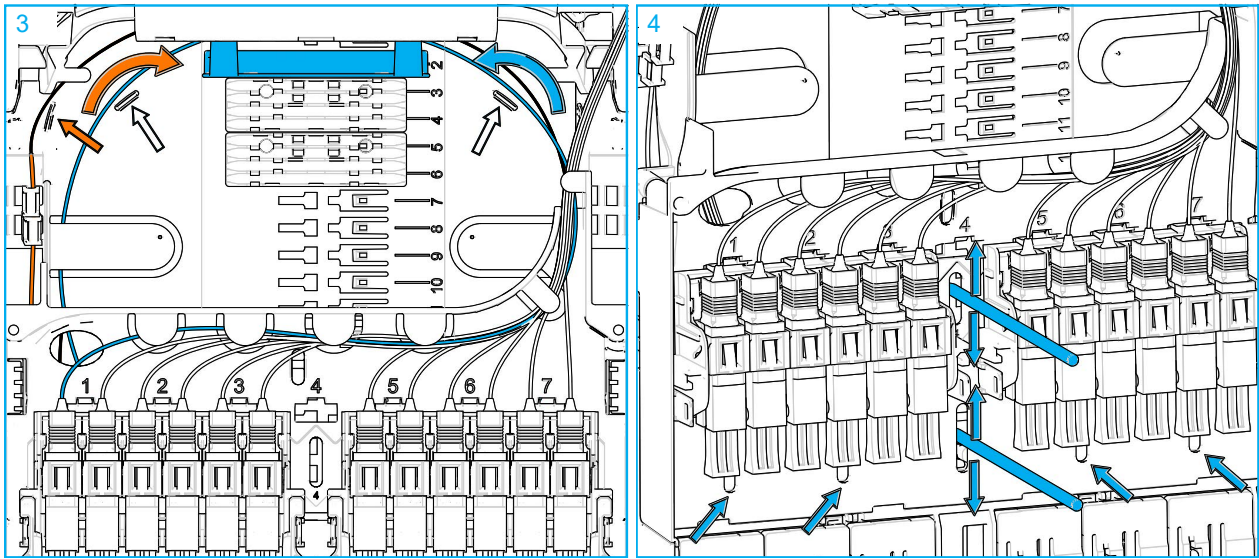

- 1 Route a subunit from the feeder cable to the front side and strip it as explained in TC-1547-IP: Basic instructions.
- 2 Remove all the 900 μ m fibers (input of the connectors) from the pocket.

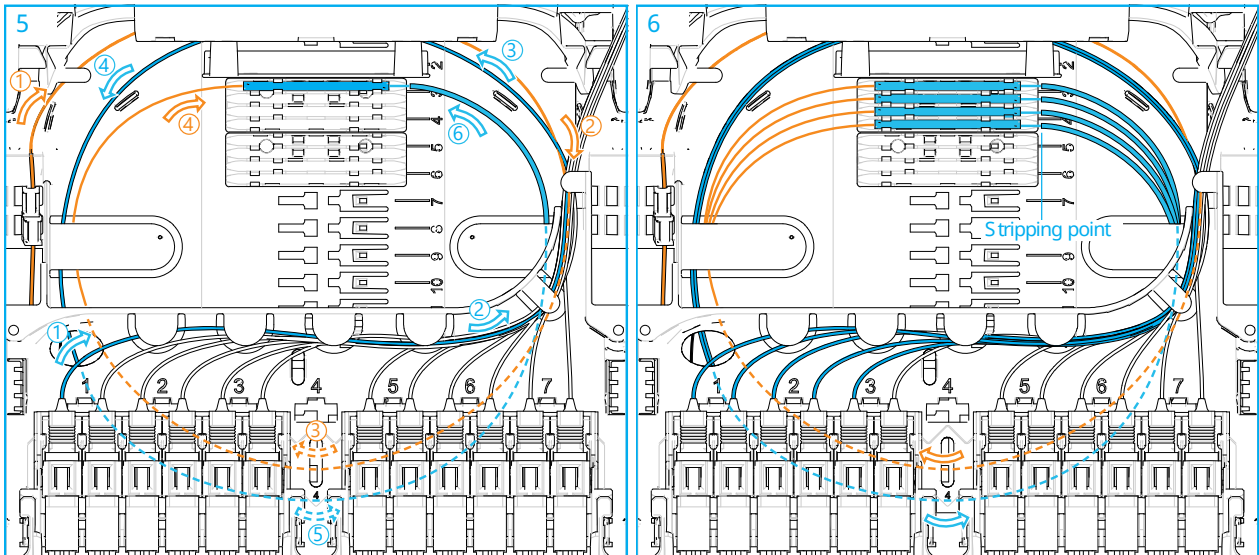

- 3 Route the feeder fibers via the opening above the stud to the pocket. Always route the fibers (feeder and drop) above the studs and the fiber hanger before continuing routing in the pocket.
- 4 Fibers in the pocket can be re-arranged by inserting a fiber guidance pen in the slots and moving the fibers up or down.



- 5 Make splice per local practice and store the splice protector in the top position of the splice protector holder.
 -  **Note:** One position can hold 3 splice protectors
- 6 Store the over lengths in loops in the over length storage area respecting following rules:
 - Always start routing the fibers above the studs and the fiber hanger. See step 3.
 - The fibers may not be routed too tightly around the fiber hanger, the splice protector holders and the splitter (holders)
 - Avoid bulging of the fiber
 - Make sure all fibers are properly positioned under the lips
 -  **Note:** The fiber guidance pen can be used to position all the fibers under the lips. Also using the holes in the pocket. See step 4.

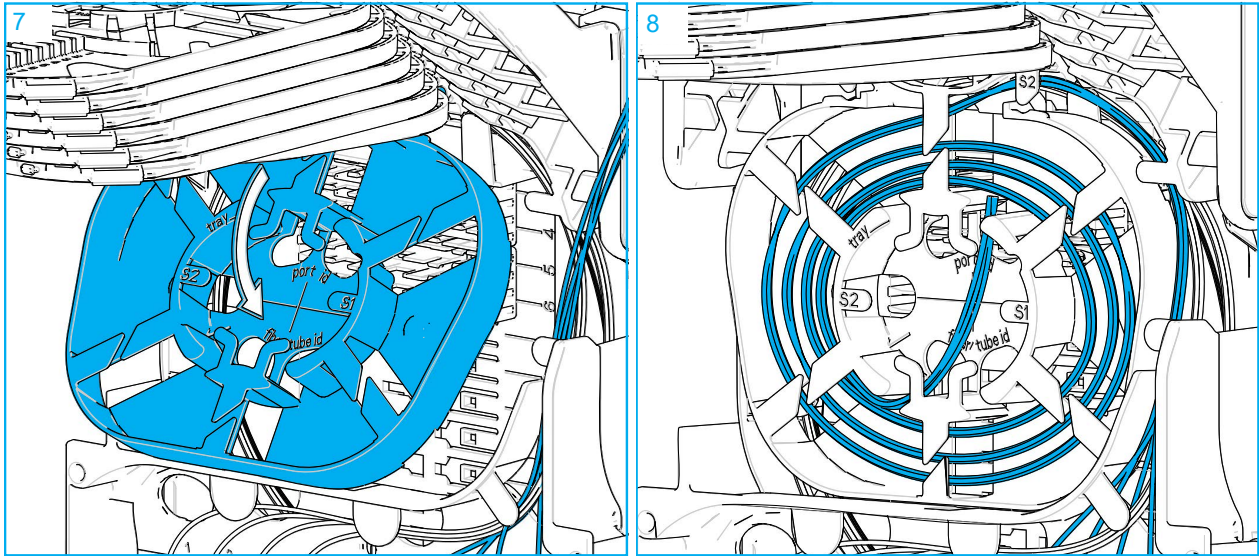

- 7 To store the input fibers of the connectors that are not spliced yet, hinge the storage tray downwards.
- 8 Store the remaining input fibers on the tray (use the outside circle only). The ends of the fibers can be stored cross through the inner circle to facilitated picking the selected fiber up again.

3.3 Splice feeder to a factory installed splitter

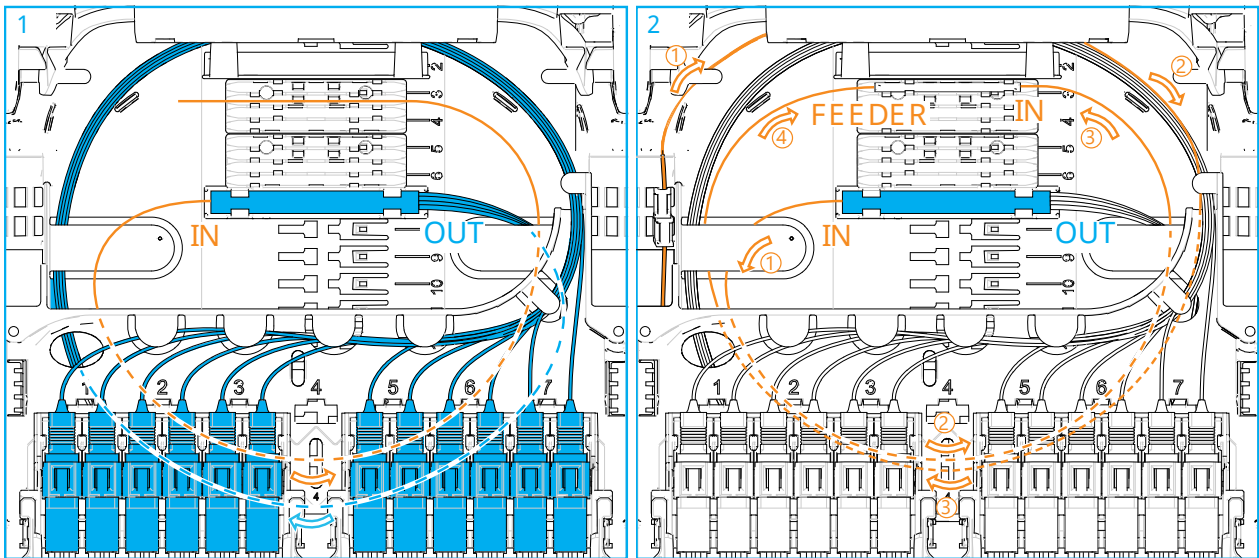

- 1 A splitter is installed in the pocket. The splitter outputs are already connected to the patch panel at the front side (input of the connectors). The input of the splitter is a 900 μ m fiber that should be stripped and spliced to a feeder fiber.
- 2 Splice the input of the splitter to the feeder fiber by making a fusion splice: make fusion splice per standard practice, store the splice protector in the splice protector holder and store over length in loops on the tray. Respect the following rules to route and store fibers in the pocket:
 - Always start routing the feeder fibers above the fiber hanger.
 - The fibers may not be routed too tightly around the fiber hanger, the splice protector holders and the splitter (holders).
 - Avoid bulging of the fiber.
 - Make sure all fibers are properly positioned under the lips.

 **Note:** The fiber guidance pen can be used to position all the fibers under the lips. Also using the holes in the pocket.

3.4 Splice feeder and input connectors to a field installable splitter

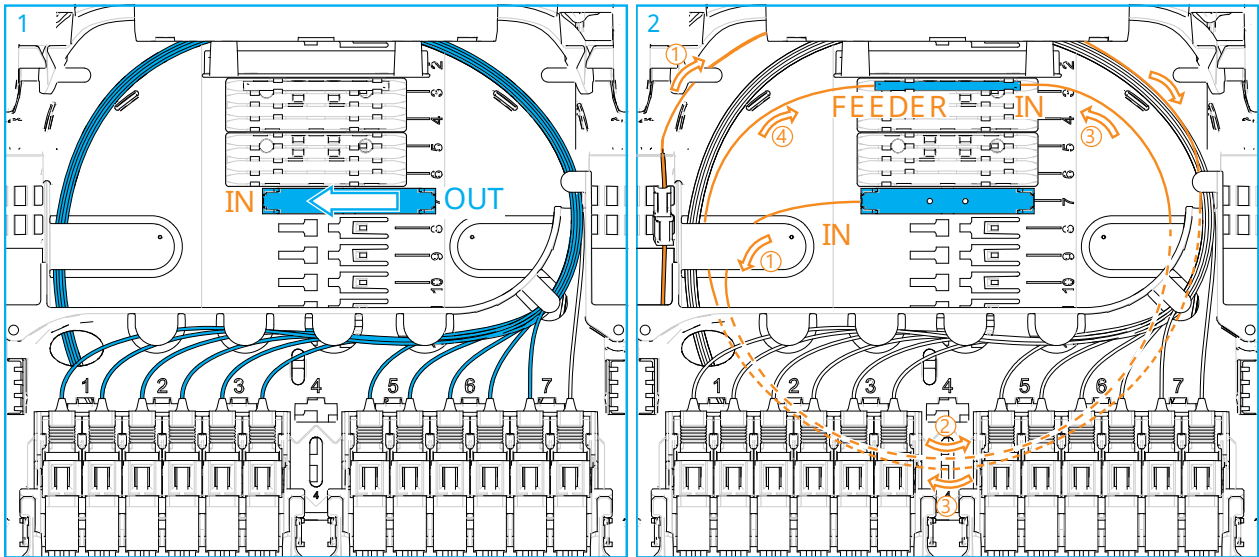

- 1 Slide the splitter in the dove tail on the pocket from left to right until a clicking sound is observed. Make sure the input of the splitter is at the left side.
- 2 Splice the input of the splitter to the feeder fiber. Store the splice protector in one of the holders in the pocket area and store over length in loops as shown.

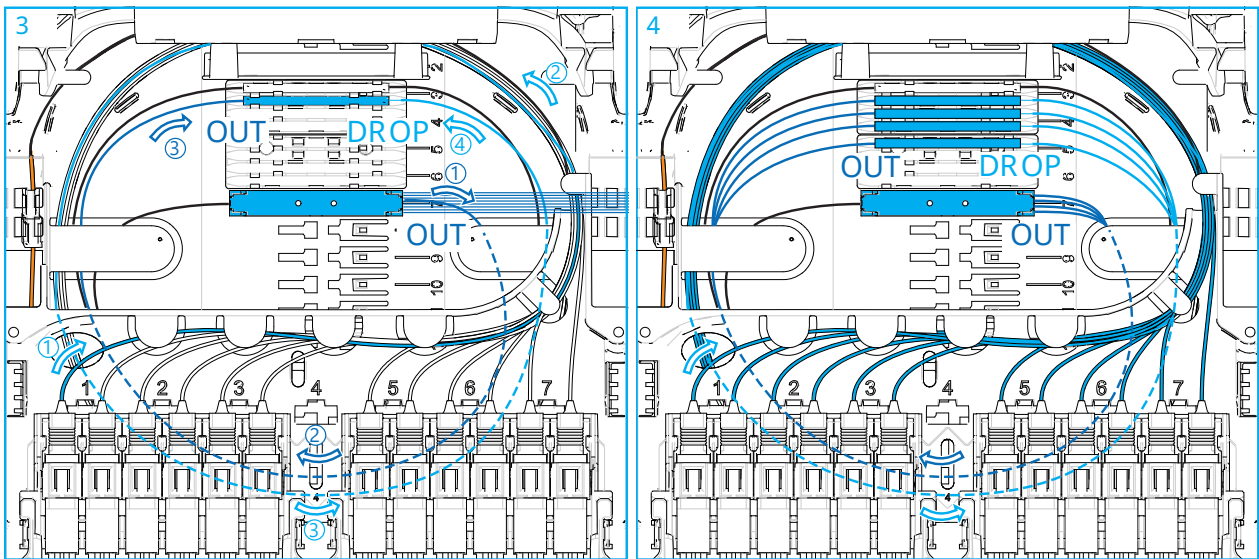

- 3 Splice the outputs of the splitter to the input of the connectors. Store the splice protector in one of the holders in the pocket area and store over length in loops as shown.

 **Note:** One position can hold 3 splice protectors.

- 4 Splitter completely installed. Respect the following rules to route and store fibers in the pocket:

- Always start routing the feeder fibers above the fiber hanger.
- The fibers may not be routed too tightly around the fiber hanger, the splice protector holders and the splitter (holders).
- Avoid bulging of the fiber.
- Make sure all fibers are properly positioned under the lips.

 **Note:** The fiber guidance pen can be used to position all the fibers under the lips. Also using the holes in the pocket.

4 Install drop cable

4.1 Install SC-connectorized cable

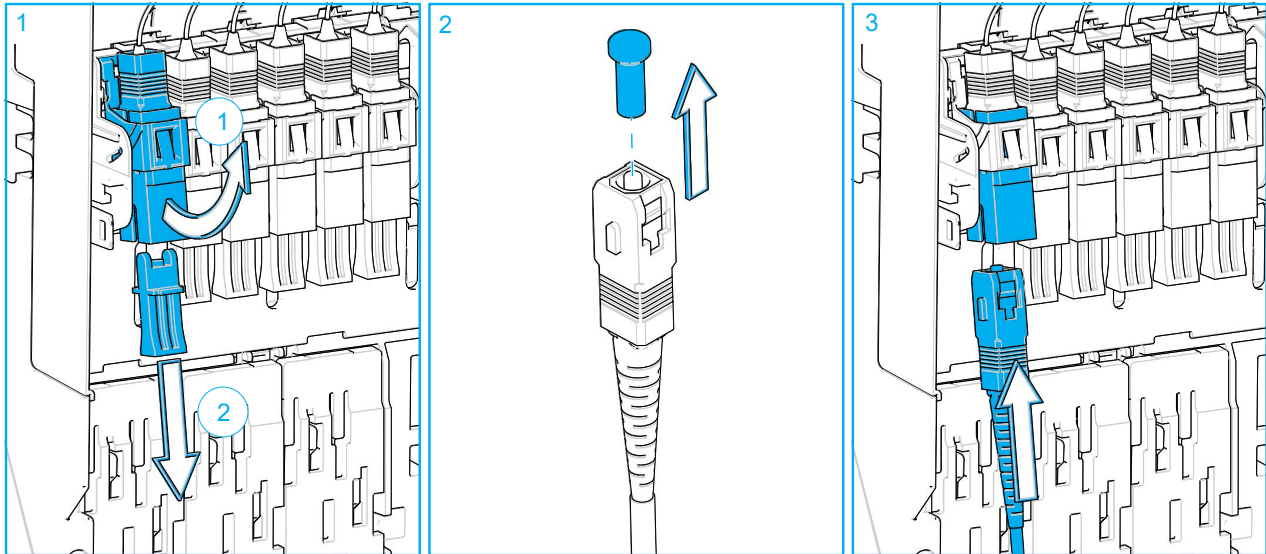

- 1 Remove the dust cap of the adapter port. Clean per standard practice.
- 2 Remove the dust cap of the connector. Clean the connector per standard practice.
- 3 Position the connector in the correct orientation (rib facing to the left as shown in figure above).

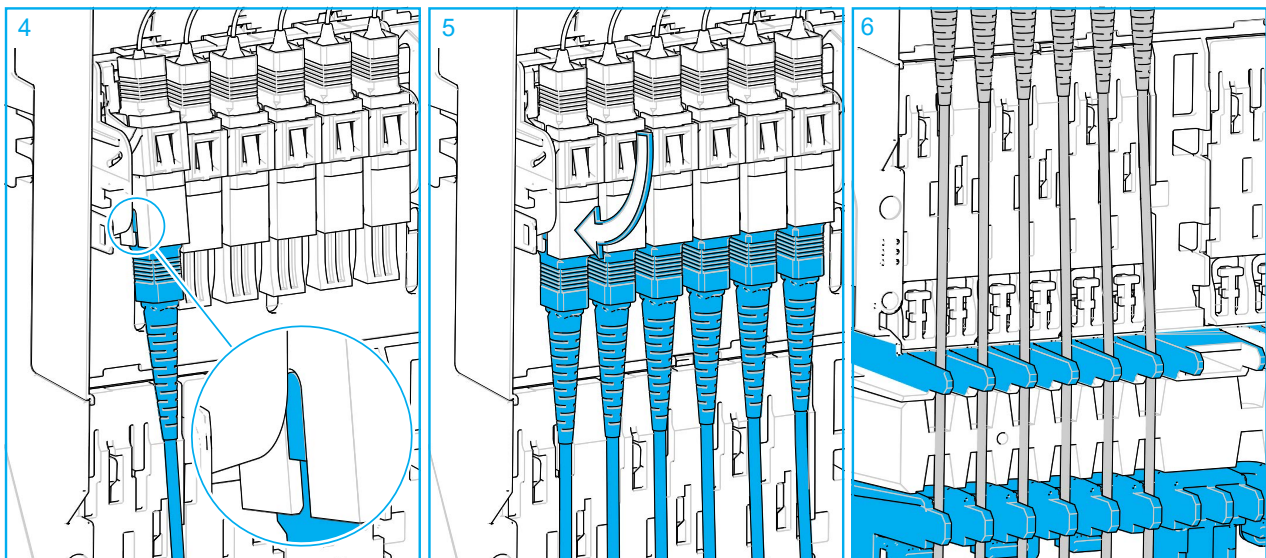

- 4 Connect the SC-connectorized cable to its assigned port. (Adapter ports are designated with the numbers 1-8.) The rib slides in the recess of the adapter. A clicking sound is observed when the connector is properly seated.
- 5 First 6 connectors installed.
- 6 Each cable should be routed to a separate entrance port. Dress each cable between the two ribs of the entrance port below the adapter port.

 **Note:** To keep the cables in place, the external drop cable fixation bracket is recommended.

4.2 Install SC Xpres drop

The Xpres drops are a range of factory terminated drop cables with integrated strain relief features.

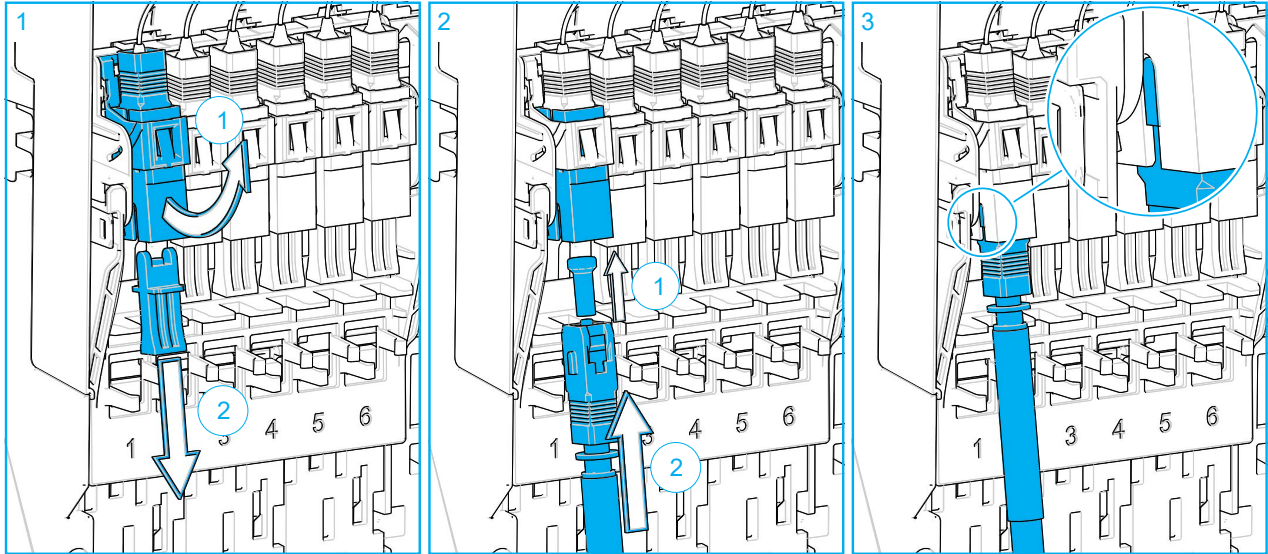

- 1 Remove the dust cap of the assigned adapter port. Clean per standard practice. Swing the adapter port upwards.
- 2 Position the connector in the correct orientation (rib facing to the left side as shown in figure above). Remove the dust cap. Clean per standard practice.
- 3 Connect the connectorized drop to its assigned port. Adapter ports are designated with the numbers 1-8. A clicking sound is observed when the connector is properly seated.

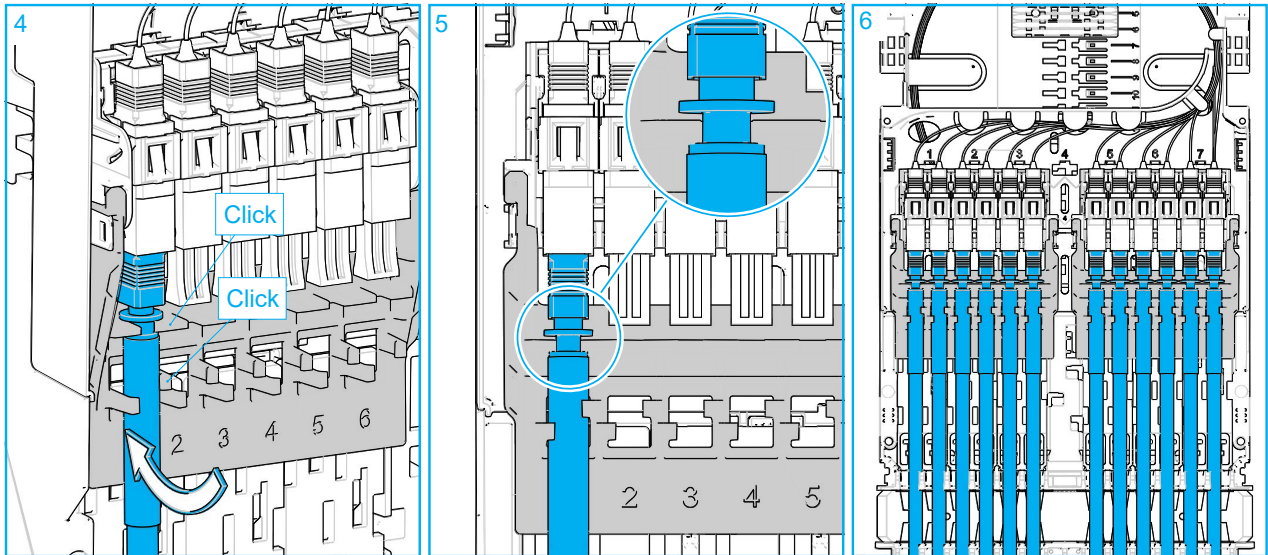

- 4 Swing the adapter port with cable back in its original position.
- 5 The metal ring just under the connector will click into the two snap features. The cable is hold between the two snap hooks positioned lower on the organizer.
- 6 All Xpres drop cables installed.

4.3 Install SC-connectorized cable in a fixed 16 patch panel

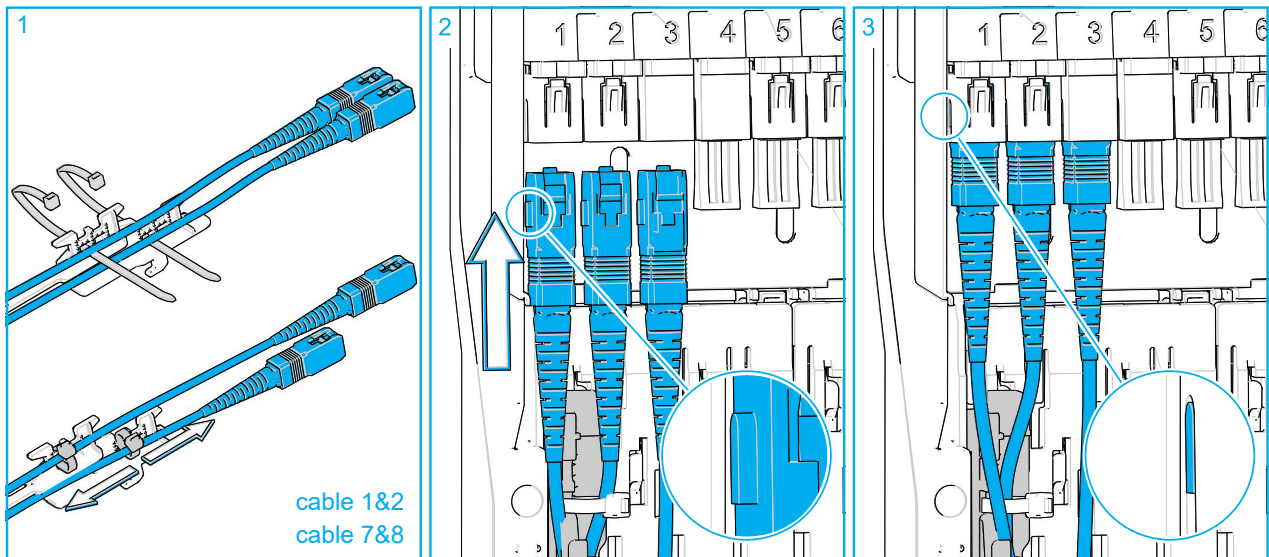

- 1 Applicable for cable 1 &2 and 7&8: install a cable tie in the slot of the carrier at the bottom position and one in the slot at the top position. Make sure the heads are oriented as shown. Install the pre-connectorized cable on each level and fasten the cable ties but don't tighten. The cable should move fluently up and down.
- 2 Install the carrier if applicable. Remove the dust caps of both the adapter and the connector. Clean per standard practice. Position the connector in the correct orientation (rib facing to the left as shown in figure above).
- 3 Connect the SC-connectorized cable to its assigned port. (Adapter ports are designated with the numbers 1-8.) The rib slides in the recess of the adapter. A clicking sound is observed when the connector is properly seated. Note that the adapter can not turn in the patch panel.

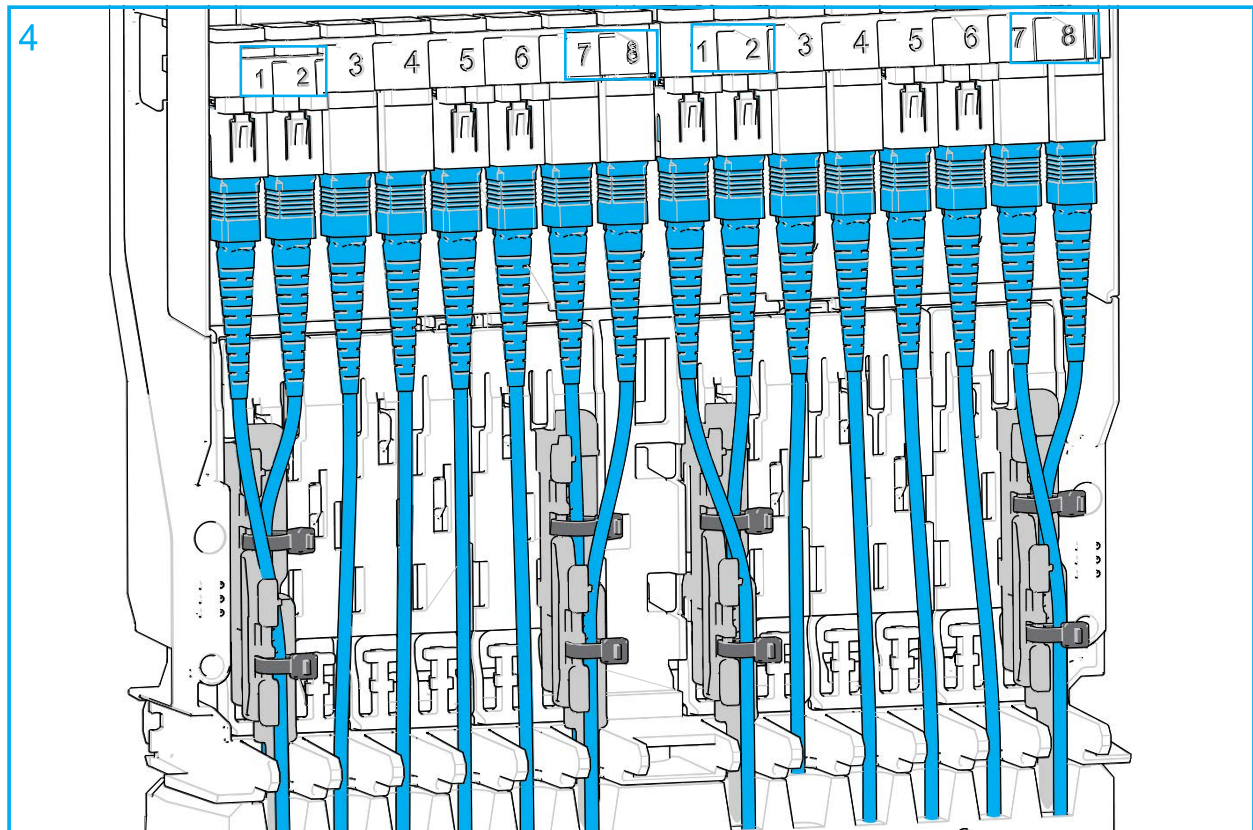

- 4 All 16 connectors installed.

 **Note:** To keep the cables in place, the external drop cable fixation bracket is recommended.

4.4 Install LC-connectorized cable

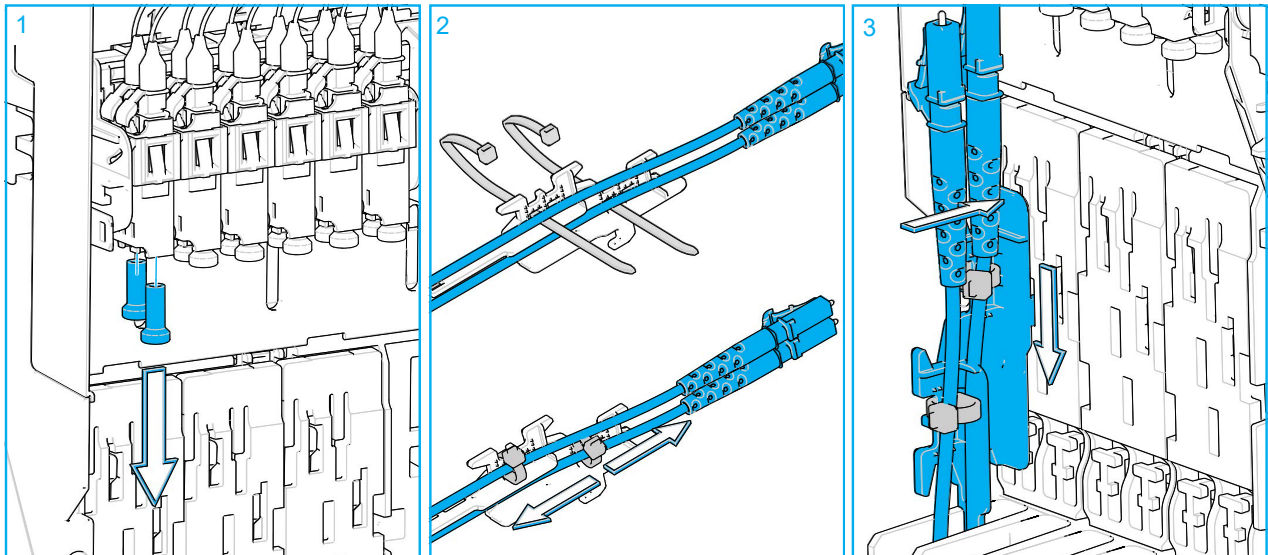

- 1 Remove the 2 dust caps of the adapter port. Clean per standard practice.
 - 2 Install a cable tie in the slot of the carrier at the bottom position and one in the slot at the top position. Make sure the heads are oriented as shown. Install the pre-connectorized cable on each level and fasten the cable ties but don't tighten. The cable should move fluently up and down.
-  **Note:** If only one cable to be installed, select the bottom position.
- 3 Slide the carrier with the cable secured into the slots of the organizer. Push the locking lip in the first slot backwards. Then Slide the carrier downwards. The locking lip returns into its original position and the carrier is correctly seated. A clicking sound is observed.

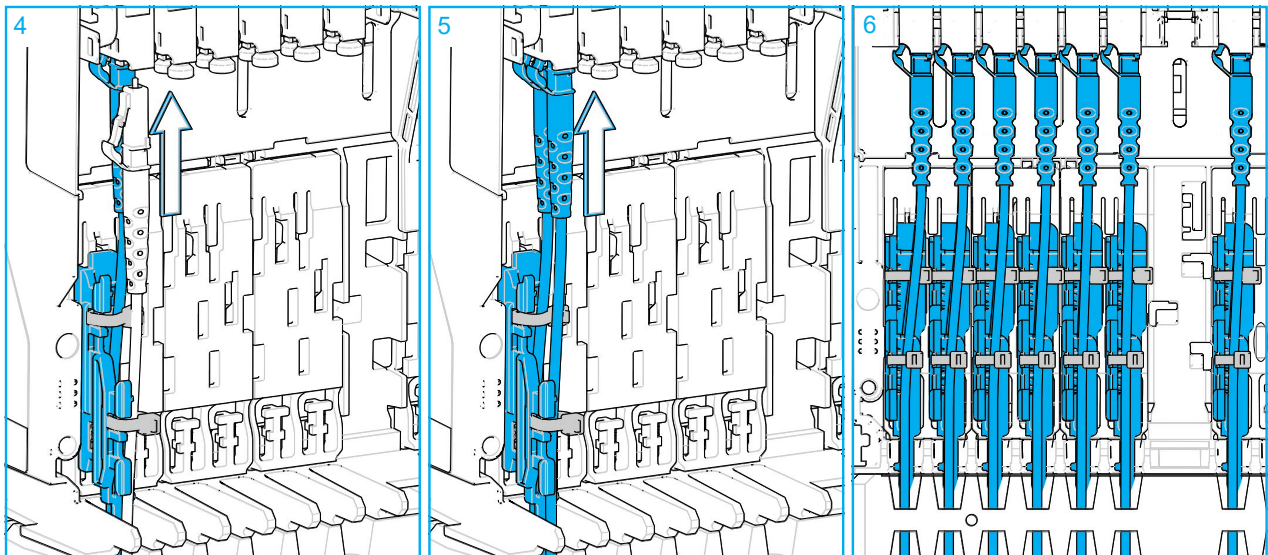

- 4 Remove the dust caps of the connectors. Clean per standard practice. Position the connector in the correct orientation (clip facing to the left side) and connect the first connector to its assigned port by sliding the connector upwards until a clicking sound is observed.
- 5 Connect the second cable following procedure explained in step 4.
- 6 In total 24 LC connectors can be installed.

 **Note:** To keep the cables in place, the external drop cable fixation bracket is recommended.

4.5 Install duplex LC Xpress drop

The Xpres drops are a range of factory terminated drop cables with integrated strain relief features. The duplex LC Xpress drop is a cable that terminates on two LC connectors that should be plugged in together in 1 duplex LC adapter.

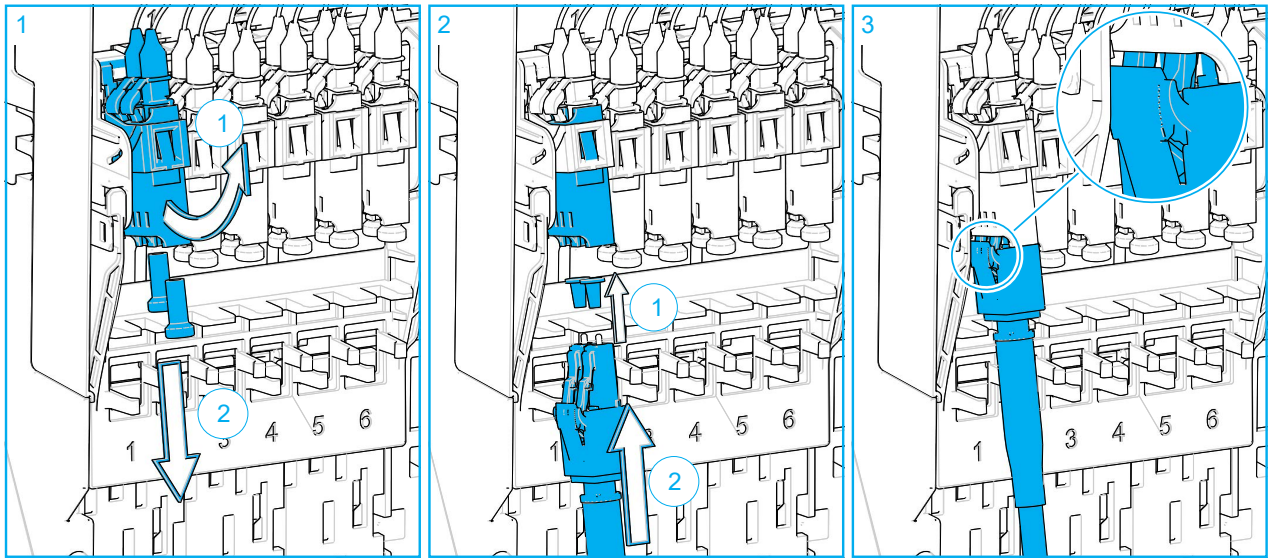

- 1 Remove the dust caps of the assigned adapter port. Clean per standard practice. Swing the adapter port upwards.
- 2 Position the connector in the correct orientation (clip facing to the left side as shown in figure above). Remove the dust cap. Clean per standard practice.
- 3 Connect the connectorized drop to its assigned port. Adapter ports are designated with the numbers 1-8. A clicking sound is observed when the connector is properly seated.

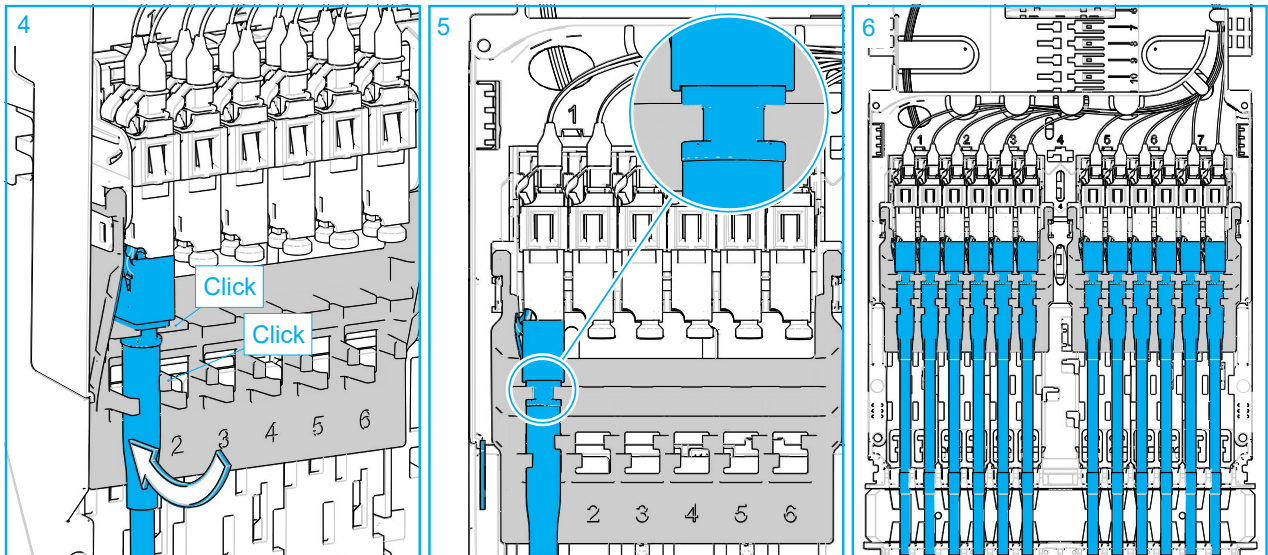

- 4 Swing the adapter port with cable back in its original position.
- 5 The metal ring just under the connector will click into the two snap features. The cable is hold between the two snap hooks positioned lower on the organizer.
- 6 All Xpres drop cables installed.

5 Disclaimer

All trademarks identified by ® are registered trademarks in the US and may be registered in other countries. All third party product names, trademarks and registered trademarks are property of their respective owners.

This product may be covered by one or more U.S. patents or their foreign equivalents. For patents, see www.cs-pat.com.

This document is not intended to modify or supplement any specifications or warranties relating to CommScope products or services.

6 Contact information

Visit our website or contact your local CommScope representative for more information. www.commscope.com

For technical assistance, customer service, or to report any missing/damaged parts, visit us at:

<http://www.commscope.com/SupportCenter>