

SRC3-U5A1B1BG005



NOVUX™ Specialty Range Closure 100, splice only, no adapters, no splitters, 12 splices, SMOUV® 45mm & 12-way ribbon splice protectors, black, 3x NVX-CR-MC-FT-NN cable retention, 1x pre-installed MHD-MODA-0020F

- Modern drop solution offering providers the agility and flexibility to use it in last-mile fiber network applications, both above and below ground
- Protected from harsh conditions by CommScope's Octopus gel sealing technology
- Agnostic to connectivity technologies: splice, connector, field-installable connector for agility and flexibility
- Identification plate for either QR code or customer logo
- QR code and CommScope cTrak® app for one-click access to all product information

Product Classification

Regional Availability	Asia EMEA Latin America North America
Regional Availability Note	Contact your local CommScope representative for specific availability
Product Type	Single-ended, rectangular fiber closure
Product Brand	NOVUX™
Product Series	SRC100

General Specifications

Cable Capacity, Drop	4 Flat 8.0 x 4.5 mm (0.30 x 0.17 in) 4 Round 1.2–8.0 mm (0.05–0.31 in)
Cable Ports Quantity, total	4 multi-out ports (8 cables)
Cable Sealing Type	Compressed gel
Cable Termination Attachments, quantity	2
Closure Sealing Type	Hinged with latch
Closure Style	Single-ended
Color	Black
Mounting	Handhole Partially buried Pedestal Wall/Pole Mount, mounting kit included
Network Area Type	Drop
Port Type	No adapter No adapter
Port, quantity	0
Splice Tray Included, quantity	1

SRC3-U5A1B1BG005

Splice Tray Type Included	12-way, heat shrink
Splicing Capacity, maximum	12
Splicing Capacity, Single Fusion, maximum	12
Splicing Type, Supported	Single fusion
Splitter Type	No splitter
Splitter, quantity	0

Dimensions



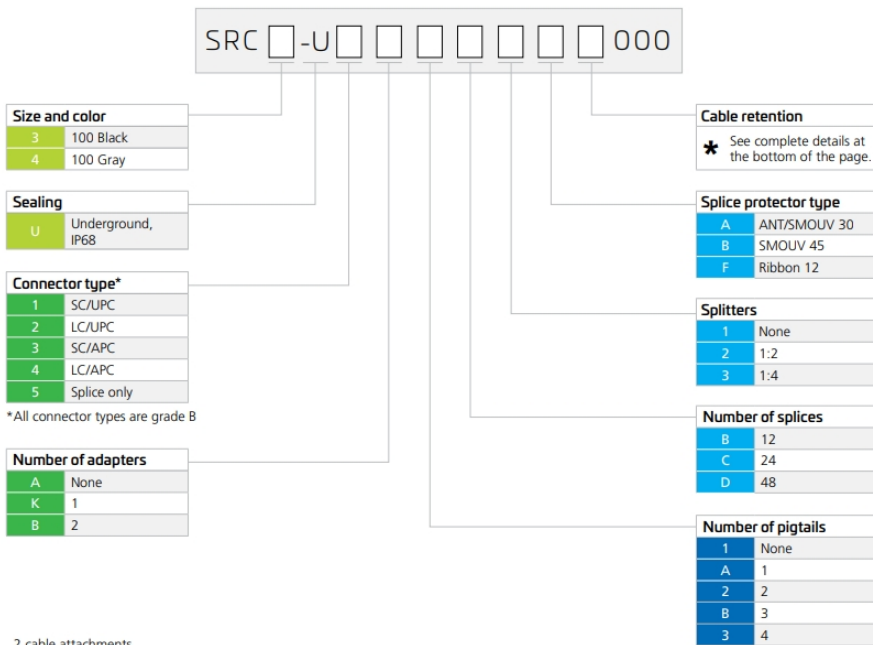

Height	267 mm 10.512 in
Width	117 mm 4.606 in
Depth	49 mm 1.929 in
Cable Entry Drop Port Diameter	8 mm (0.31 in) mm

Ordering Tree

SRC3-U5A1B1BG005



2 cable attachments are supplied.

Cable retention*	Cable Termination Unit (CTU) options					
A	None	B	C	D	E	F
B	NVX-CR-MC-FT-NN					
C	NVX-CR-MC-RD-NN	NVX-CR-MC-FT-NN	NVX-CR-MC-RD-NN	NVX-CR-SA-SM-NN	NVX-CR-TI-SM-NN	NVX-CR-DU-FL-NN
D	NVX-CR-SA-SM-NN	• Flat cable	• Round cable	• Round cable	• Round cable	• Round cable
E	NVX-CR-TI-SM-NN	• Metal clip	• Metal clip	• Dia up to 8 mm	• Dia up to 8 mm	• Dia up to 6.2 mm
F	NVX-CR-DU-FL-NN	• Range 3 x 5 to 4 x 8 mm	• Range 4 to 6.2 mm	• Strength member	• Aramide yarns	• Aramide yarns
G	4xNVX-CR-MC-FT-NN			• Aramide yarns	• Single layer	• Dual layer
H	4xNVX-CR-MC-RD-NN			• Single layer		• Compact length
I	4xNVX-CR-SA-SM-NN					
J	4xNVX-CR-TI-SM-NN					
K	4xNVX-CR-DU-FL-NN					
L	2xNVX-CR-MC-FT-NN and 2xNVX-CR-MC-RD-NN					

Material Specifications

Material Type Impact-resistant polymer

Optical Specifications

Fiber Type G.652.D | G.657.A1 | G.657.A2 | G.657.B3

Environmental Specifications

Operating Temperature -40 °C to +70 °C (-40 °F to +158 °F)

Environmental Space Above ground | Below ground | Direct burial

Qualification Standards IEC 60529, IP68 + 2 m waterhead | IEC 61753-1, category G

UV Resistance UV stabilized

SRC3-U5A1B1BG005

Water Resistance

Flash test valve at 2 psi (20 kPa)

Packaging and Weights

Packaging quantity

10

Packaging Type

Box | Carton

Included Products

- MHD-M0DA-0020F – Hardened Multifiber Optical Connector (HMFOC) cable assembly, HMFOC jack to stub, 12-fiber, 20 feet
- NVX-CR-MC-FT-NN – NOVUX™ Cable Termination Unit (CTU) for flat cables with 3x5 to 4x8 mm diameter, metal clip

MHD-MODA-0020F



Hardened Multifiber Optical Connector (HMFOC) cable assembly, HMFOC jack to stub, 12-fiber, 20 feet

- Hardened connectors are factory-terminated and environmentally sealed for use in optical drop cable deployments
- Hardened drop cables incorporate hardened connector technology that is designed to withstand the rugged outside plant environment
- Hardened drop cables simplify installation and maintenance by reducing splicing requirements in the distribution portion of the network

Product Classification

Regional Availability	Asia Latin America North America
Portfolio	CommScope®
Product Type	Fiber drop cable assembly
Product Series	MHD

General Specifications

Cable Type	Dielectric - Flat
Connector A, quantity	1
Color, boot A	Black
Color, connector A	Black
Interface, Connector A	Hardened multi-fiber (HMFOC) jack
Interface Feature, connector A	Male
Interface, Connector B	Unterminated
Jacket Color	Black
Total Fibers, quantity	12

Dimensions

Cable Assembly Length	6.096 m 20 ft
Cable Outer Diameter	4.3 x 8.0 mm (0.17 x 0.31 in)

Ordering Tree

MHD-MODA-0020F

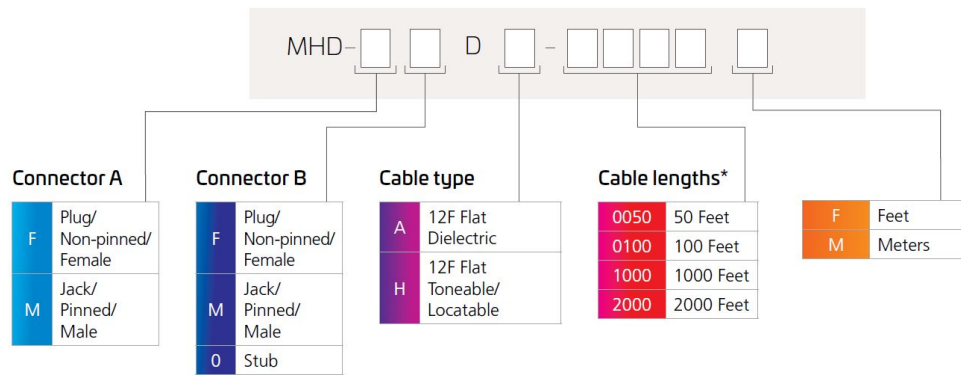

* Cable Length shown as an example, additional cable lengths available upon request up to 2,000 ft. (600 m).

Representative Image

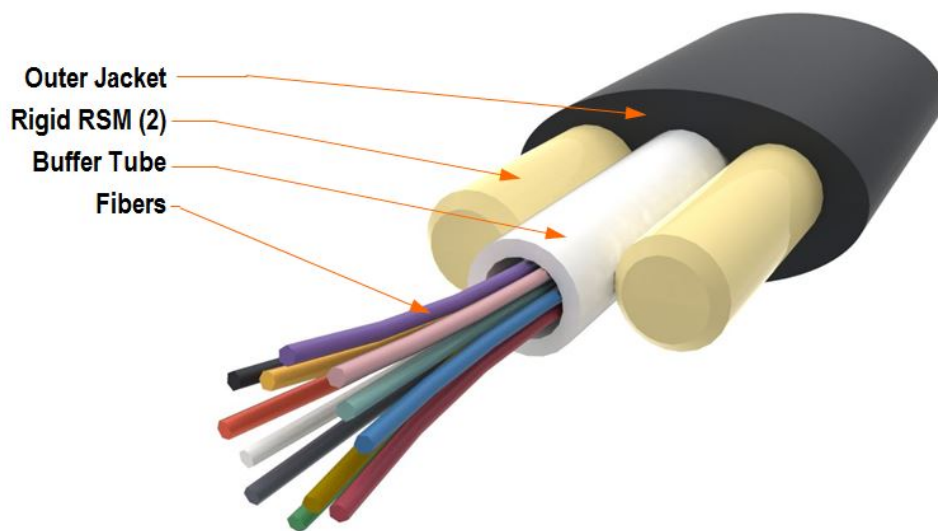

Mechanical Specifications

Minimum Bend Radius, loaded	86 mm 3.386 in
Minimum Bend Radius, unloaded	81 mm 3.189 in
Tensile Load, long term, maximum	400 N 89.924 lbf
Tensile Load, short term, maximum	1334 N 299.895 lbf

Optical Specifications

Fiber Mode	Singlemode
-------------------	------------

MHD-MODA-0020F

Fiber Type	G.657.A2
Insertion Loss, maximum, connector A	0.45 dB
Return Loss, minimum, connector A	65 dB

Environmental Specifications

Installation temperature	-30 °C to +70 °C (-22 °F to +158 °F)
Operating Temperature	-40 °C to +70 °C (-40 °F to +158 °F)
Storage Temperature	-40 °C to +75 °C (-40 °F to +167 °F)
Environmental Space	Outdoor, buried
Jacket UV Resistance	UV stabilized

Packaging and Weights

Packaging quantity	1
---------------------------	---

Regulatory Compliance/Certifications

Agency	Classification
CHINA-ROHS	Below maximum concentration value
REACH-SVHC	Compliant as per SVHC revision on www.commscope.com/ProductCompliance
ROHS	Compliant
UK-ROHS	Compliant



NVX-CR-MC-FT-NN



NOVUX™ Cable Termination Unit (CTU) for flat cables with 3x5 to 4x8 mm diameter, metal clip

Product Classification

Regional Availability	Asia EMEA Latin America North America
Product Type	Cable termination kit
Product Brand	NOVUX™
Product Series	CSC

General Specifications

Application	For use with CSC Fiber closures
Color	Black

Packaging and Weights

Packaging quantity	20
Packaging Type	Bag Box

Regulatory Compliance/Certifications

Agency	Classification
CHINA-ROHS	Below maximum concentration value
REACH-SVHC	Compliant as per SVHC revision on www.commscope.com/ProductCompliance
ROHS	Compliant
UK-ROHS	Compliant

